

2017年6月 第3期 总第107期 The 3rd Issue June 2017 Issue 107

今日长飞



P26 长飞公司企业文化课堂
Corporate Culture Classroom of YOFC

双月刊



2017年6月 第3期 总第107期

主 编：庄 丹

执行主编：周钦敏

副 主 编：闫长鹏 张 穆 郑 昕 罗 杰
江志康 王瑞春 童维军 聂 磊
梁冠宁 王大为 蒋 涓 文潇江
肖 毅 汤金宽 陈慧雄 韩庆荣
龙胜亚 刘爱华 刘国峰 孙志宇
彭国泰

编 辑：黄 巧 赵 璇 吴婉琴 李佳静
杭常东 王 瑛 魏华珍 刘 燕
童明月 任安然 常 青 何小琼
赵 蕊 陈煜挺 李 路 卢志慧
李 静 邹 奕 梁 慧 章璐娴
许 波 Vivi

Chief editor : Zhuang Dan

Managing editor : Zhou Qinmin

Deputy editor : Yan Changkun

Zhang Mu Zheng Xin Luo Jie

Jiang Zhikang Wang Ruichun

Tong Weijun Nie Lei Liang Guanning

Wang Dawei Jiang Yun Wen Xiaojiang

Xiao Yi Tang Jinkuan Chen Huixiong

Han Qingrong Long Shengya Liu Aihua

Liu Guofeng Sun Zhiyu Peng Guotai

Editor: Huang Qiao Zhao Xuan

Wu Wanqin Li Jiajing Hang Changdong

Wang Ying Wei Huazhen Liu Yan

Tong Mingyue Ren Anran Chang Qing

He Xiaoqiong Zhao Rui Chen Yuting

Li Lu Lu Zhihui Li Jing Zou Yi

Liang Hui Zhang Luxian Xu Bo Vivi

Contents 目录

02 刊首语 Foreword

以企业文化引领长飞发展

Enterprise Culture Leads the Development of YOFC

04 新闻 / 要闻 News

长飞公司再登央视，展现领军企业风采

Appeared Again in CCTV, YOFC Displayed the Features of Leading Enterprises



06 长飞公司成立科学技术协会

YOFC Established Association for Science and Technology

08 长飞印尼光通信公司举行奠基仪式

Cornerstone Laying Ceremony of PT Yangtze Optics Indonesia

10 新闻 / 简讯 News

长飞公司强势中标2017~2018年中国联通光缆集采

YOFC Won the Bidding of China Unicom's Central Purchase of Optical Fibre in 2017-2018 with Good Result

11 湖北省委书记蒋超良一行视察长飞潜江科技园

Secretary of Hubei Provincial Party Committee Jiang Chaoliang and His Company Visited YOFC Qianjiang High-tech Industrial Park

12 长飞公司召开第五届光缆技术质量交流会

YOFC Held the 5th of Optical Cable Technology Quality Meeting

13 长飞公司气吹微缆实现高速生产

YOFC Realized High-speed Production of Air-blowing Micro Cables

14

长飞沈阳公司爱心基金会组织“敬老院送温暖”公益活动

YOFC(Shenyang) Love Foundation Organized the Public Service Activity of “Sending Warmth to Nursing Homes”

15

南非财政部长一行访问长飞非洲公司
South African Finance Minister visited YOFC

16

长飞光纤印尼公司产品出口东盟国家
YOFC Exported Fibre to Asean Country

17

新闻 / 获奖 News

长飞公司与中国联通联合项目荣获中国电子学会科学技术奖一等奖
Joint Project of YOFC and China Unicom Won the First Prize of Chinese Institute of Electronics Scientific and Technological Award

18

长飞公司先进光纤及预制棒制备平台关键技术项目荣获湖北省科技进步二等奖

Key Technology Project of Advanced Optical Fibre and Preform Fabrication Platform of YOFC Awarded the Second Prize of Hubei Provincial Technology Advancement Award

19

长飞公司首席技师钟升荣膺武汉市“大城工匠”称号
Principal Technical Officer of YOFC Zhong Sheng Awarded the Title of "Craftsmen of City" in Wuhan

20

新闻 / 会议 News

IEC SC86A光纤光缆标准工作组会议在京召开
IEC SC86A Optical Fibre and Cable Standards Work Group Meeting was Held in Beijing

21

长飞公司应邀出席中国-加拿大合作论坛
YOFC was Invited to Attend China-Canada Collaboration Forum

22

新闻 / 展会 News

长飞公司亮相2017香港世界数据中心展
YOFC Attended 2017 Data Center World Hong Kong

23

筑梦“狮城” 长飞公司闪耀亚洲国际通信与信息展
Build Our Dream in "Lion City", YOFC Attended CommunicAsia

24

长飞公司参加2017 FTTH 亚太会议
YOFC Attended FTTH Council Asia-Pacific Conference

25

长飞公司闪耀2017中国海绵城市与综合管廊展
YOFC Attended China Sponge City & Comprehensive Pipe Gallery Expo 2017

26

专题 Special

长飞公司企业文化课堂
Corporate Culture Classroom of YOFC

32

VAD项目小记
A Recount of VAD Project

38

安全于心 安全于行
Safety in Mind, Safety in Behavior

40

产品 Products

多芯少模光纤在传感领域的应用
Application of Multi-core and Few-mode Fibre in Sensing Field

46

员工风采 Employee

长飞公司举行第四届气排球比赛
The 4th Balloon Volleyball Competition of YOFC

48

累并快乐着——光缆部拓展训练小记
Tired but Happy—A Recount of Outward Training in Optical Cable Department

50

激情飞扬 谁“羽”争锋
With Full of Passion, Who will Be the Winner

52

快乐工作 快乐生活——长飞兰州公司与和盛堂药业公司举行系列联谊活动
Happy Work, Happy Life
— The Serial Fellowship Activity of YOFC (Lanzhou) with Holyshine Pharmaceutical Company

以企业文化 引领长飞发展

企业文化是企业发展的持续动力，决定企业发展方向，也是构成企业核心竞争力的关键因素。企业文化需要长期、持续的投入、建设、创新、改进和优化，才能最终使其外塑于形、内化于心，在企业落地生根，为企业发展增添活力、动力和创造力。企业文化建设解决的是企业长远生存发展的问题，是长远发展的结果。纵观中外优秀的组织或企业，无不以鲜明的个性、坚定的信念创造了一个又一个经营奇迹，这便是文化的力量。

企业根深叶茂源于思想和文化传承，欲强大一家企业，必先强大其心智与精神。长飞在29年的发展历程中，务实兴业、锐意进取，留下了一个又一个闪光的足迹，积淀了许多优秀的文化基因。在长飞初创期，公司合资双方以信任和合作为基础，形成了以“信任、奉献、责任、进取”为核心的企业精神；在发展成长期，公司提炼出完整的企业文化，形成以“责任”、“客户”为核心元素的企业文化体系，“以客户为中心，做有责任心的长飞人”伴随着长飞发展壮大；现阶段，公司再次梳理、提炼企业文化体系，确立并发布新的核心企业文化及子文化，启动新一轮企业文化建设。

长飞的理想是成为信息传输与智慧联接领域的领导者，为了实现这个理想，长飞需要根植自己长盛的基因，通过塑造长飞的个性、精神与灵魂，照亮长飞前进的征程，走向更加美好的明天！





Enterprise Culture Leads the Development of YOFC

Enterprise culture is a sustained motive force for the development of an enterprise. It determines the direction of enterprise development and is also a key factor in constituting the core competitiveness of an enterprise. Enterprise culture calls for long-term and continuous input, building, innovation, improvement and optimization, which enables an enterprise to present a good image outside and foster the correct values inside, making culture take root in the business in an effort to bring vitality, impetus and creativity. Enterprise culture building aims to solve the problems of an enterprise's long-term survival and development which result from long-term development. All outstanding organizations and enterprises at home and abroad have created one operation miracle after another through distinct personality and firm belief, representing the power of culture.

To build a strong enterprise, the top priority is to enhance the mentality and spirit of the organization, and be devoted to inheriting and continuing everlasting thought and culture. Over its development process of 29 years, YOFC has committed itself to running its business and forging ahead in a practical and enterprising manner, left one sparkling footprint after another and accumulated a number of excellent cultural genes. At the initial stage of YOFC, on the basis of trust and cooperation,

both parties to the joint venture formed the enterprise spirit featured by "trust, dedication, responsibility and diligence"; at its maturity, the company has refined the complete enterprise culture and forged the complete enterprise culture system with "accountability and client" as core elements and "focusing on clients and being an accountable YOFC employee" is accompanied by the company growth; currently, the company again straightens out and refines the enterprise culture system to ensure and issue the new enterprise core culture and sub-culture and launch a new round of enterprise culture construction.

The ideal of YOFC is to become a leader in the field of information transmission and smart link. To realize this ideal, YOFC needs to cultivate its own flourishing genes. Only by forging YOFC's personality, spirit and soul can it have bright prospects ahead and create a better future.

A stylized, handwritten signature in black ink, consisting of several fluid, connected strokes.

长飞公司再登央视 展现领军企业风采

□ 本刊编辑部



作为全球领先的光纤光缆企业，长飞公司在技术创新、智能制造等方面已取得众多成就，引起社会广泛关注。近年来中央电视台《新闻联播》、《经济半小时》、《经济信息联播》等栏目，以及《人民日报》、《新华社》、《经济日报》等媒体纷纷对长飞公司进行宣传报道。近日，长飞公司再次登上央视《对话》、《新闻联播》、《晚间新闻》等栏目，进一步彰显了公司的发展水平和品牌影响力。

4月28日，中央电视台财经频道《对话》栏目在北京举行首届“中国实业振兴峰会”。此次峰会是中央电视台财经频道年度重磅策划“为中国实业代言”系列活动的重要环节，国家发展和改革委员会主任何立峰、工业与信息化部部长苗圩、国务院国资委主任肖亚庆等部委领导为大会致辞，长飞公司执行董事兼总裁庄丹应邀出席此次峰会并作为武汉市唯一的企业代表上台发言。

庄总在会上分享了长飞公司在践行实体经济转型升级道路上的探索感悟，并分别从推进智能制造，提升企业整体效能，实现从制造向“智造”的转型；不断突破行业技术壁垒，

掌握核心技术，坚持技术创新；提升质量水平，追求卓越品质，打造全球品牌；依托“一带一路”国家倡议，进行全球化产业布局四个方面分享了长飞公司的发展历程。庄总坦言做实业会很辛苦，但只要坚持下去，一定会取得好的成果和回报，引起了与会嘉宾的共鸣。

尤为值得一提的是，除了出席首届“中国实业振兴峰会”，长飞公司再登央视《新闻联播》。端午节期间，央视《新闻联播》栏目推出“为了我的国”系列报道，展现各行各业的中国人只争朝夕、团结奋进的精气神。5月30日，长飞公司作为科技创新企业的代表，被该栏目“为了我的国”系列报道以头条播出。在此次报道中，长飞公司展示了全球最细最快的光纤和全球最大尺寸的光纤预制棒，以及先进的预制棒生产工艺。次日，央视《晚间新闻》栏目对长飞公司的技术创新再次进行播报。

经过近30年的发展，长飞公司走出了一条技术引进、消化、吸收、再创新到输出的成功之路。未来，长飞公司将以“智慧联接 美好生活”为己任，致力于成为信息传输与智慧联接领域的领导者。

Appeared Again in CCTV, YOFC Displayed the Features of Leading Enterprises

□ The Editorial

As a world's leading fibre and cable enterprise, YOFC has made great achievements in technical innovation and intelligent manufacturing, attracting wide social attention and winning the approval of the central media. In recent years, the news of YOFC has been covered by columns such as CCTV News, Half-Hour Economy and Economic News and media such as People's Daily, Xinhua News Agency and Economic Daily. Recently, YOFC has appeared in columns such as CCTV Dialogue, News and Night News again, indicating its development and brand influence.

On April 28, the first "China Industrial Revitalization Summit" was held in Beijing at the Dialogue column on the channel of finance and economics of CCTV. The summit is an important part of the serial event "Speak for Chinese Industry", a big plan of the channel of finance and economics of CCTV in 2017. He Lifeng, Director of National Development and Reform Commission, Miao Wei, Minister of Ministry of Industry and Information Technology, Xiao Yaqing, Director of State-owned Assets Supervision and Administration Commission of the State Council and other leaders of ministries and commissions delivered speeches for the summit. At the invitation, Zhuang Dan, Executive Director & President of YOFC, attended the summit and delivered a speech

as the only enterprise representative in Wuhan City.

At the summit, President Zhuang shared his perception of YOFC in following the pathway of industrial transformation and upgrade and shared the development of YOFC in four aspects, specifically, promoting intelligent manufacturing, improving the overall effectiveness of the enterprise and realizing the transformation from manufacturing to "intelligent manufacturing"; continuously breaking the technical barrier in the industry, grasping the core technology, insisting on technical innovation; improving the quality, seeking excellent quality and creating the global brand; relying on the "Belt and Road" Initiative and making a global industrial layout. President Zhuang was frank to admit that it is tough for industries. However, by sticking to the goal, industries in China will definitely reap the benefits, which was agreed by participants.

It is noteworthy that in addition to the first "China Industrial Revitalization Summit", YOFC again appeared in CCTV News. During the Dragon Boat Festival, CCTV News has promoted the serial report of "For



My Country" to display the united and hardworking Chinese people in different walks of life. On May 30, as the representative enterprise of scientific and technological innovation, YOFC hit the headlines of the serial report of "For My Country". In this report, YOFC has displayed the world's thinnest and fastest fibre and world's largest fibre preform as well as advanced preform production technique. The next day, YOFC's technical innovation was again covered by CCTV Night News.

Through nearly 30 years of development, YOFC has blazed a trail to success of technical introduction, digestion, absorption, innovation and output. In the future, with the "Smart Link, Better Life" as its own duty, YOFC will be committed to becoming the leader in the field of information transmission and smart link.

长飞公司成立科学技术协会

□ 国家重点实验室 吕大娟



6月7日，长飞公司科学技术协会（以下简称“长飞科协”）成立大会隆重召开。武汉市科协党组成员、副主席陈光勇，东湖新技术开发区科技创新局局长李世庭，武汉市科协企事业单位部部长宋卫华，长飞公司执行董事兼总裁庄丹，副总裁闫长鹏，技术总监罗杰，研发中心总经理王瑞春等出席了此次会议。

大会由长飞公司执行董事兼总裁庄丹致辞，庄总表示，科技研发人员和高技术人才是长飞公司的宝贵资源和重要的员工群体，长飞科协的成立是公司在创新驱动发展进程中的一件大事，对加强企业文化建设，加快提高企业技术创新能力具有十分重要的意义。武汉市科协企事业单位部部长宋卫华宣读了武汉市科协同意长飞公司成立企业科协的批复

文件，大会通过了《长飞光纤光缆股份有限公司科协章程》，选举并产生了以长飞公司庄总为主席的第一届长飞科协委员会领导机构。

作为新当选的长飞科协主席，庄总在会上发表了重要讲话，并对长飞科协的未来工作提出了两点要求：一是多走访、多取经，向市、区级各科协多学习成功经验；二是要围绕公司未来发展战略而有所为，有针对性地做好重要工作。

武汉市科协党组成员、副主席陈光勇在讲话中充分肯定了长飞公司在全球光纤光缆行业所取得的重要成就和领先地位，并对长飞科协提出了三点宝贵建议：长飞科协要把学术交流和科学普及放在优先的地位，通过学科交叉、创新发展，把科协组织真正发展为“科技

工作者之家”；要切实服务于长飞公司的中心任务，做好创新驱动发展，充分发挥长飞核心科技人才的积极性，把建立院士工作站纳入议程；希望长飞科协的科技工作者团结拼搏、开拓创新，充分发挥科技优势，为武汉市、湖北省的科技发展服务。

东湖新技术开发区科技创新局局长李世庭对长飞公司成立企业科协表示祝贺，并希望长飞科协在省、市科协的指导下，按照章程做好科协工作。同时李局长强调，科普是一辈子的事情，长飞科协要传承好科技创新文化，努力发展成为开发区和武汉市科协的优秀示范科协组织，开发区将在后勤保障、人才服务方面提供必要的支持，协助推动长飞公司科研水平更上一层楼。

YOFC Established Association for Science and Technology

□ Lv Dajuan from the State Key Laboratory

The inaugurating meeting for Association for Science and Technology (hereinafter referred to as "YOFC AST") of YOFC was ceremoniously held on June, 7. Chen Guangyong, Member of the CPC Leadership Group and Vice Chairman of Wuhan Association for Science and Technology, Li Shiting, Director-general of Science and Technology Innovation Bureau of East Lake High-tech Development Zone, Song Weihua, Director of Enterprise and Institution Department of Wuhan Association for Science and Technology, Zhuang Dan, YOFC Executive Director & President, Yan Changkun, Vice President, Luo Jie, Technical Director, Wang Ruichun, General Manager of the R&D Center and other representatives attended the meeting.

At the meeting, Zhuang Dan, YOFC Executive Director & President delivered an address, noting that scientific R&D personnel and high-tech talents are valuable resources and significant employees of the company. The establishment of YOFC AST is an important event for the company during its process of innovation-driven development and of great significance for strengthening enterprise culture construction and speeding up the improvement of corporate technological innovation capacity. Song Weihua, Director of Enterprise and Institution Department of Wuhan Association for Science and Technology, read out the approval document on YOFC's establishment of association for science and technology. The meeting adopted the Articles of Association for Science and Technology of Yangtze Optical

Fibre and Cable Joint Stock Limited Company, selected and constituted the first leading organ of YOFC AST Committee presided by Zhuang Dan, YOFC President.

As the newly-elected Chairman of YOFC AST, President

Zhuang delivered a keynote speech at the meeting and put forward two requirements for the future work of YOFC AST: the first is to visit more and study more to learn the successful experience from municipal or regional associations for science and technology; the second is to do the relevant and important work around YOFC's future development strategy.

At his speech, Chen Guangyong, Member of the CPC Leadership Group and Vice Chairman of Wuhan Association for Science and Technology, fully acclaimed the major achievements and leading status of YOFC in the global optical fibre and cable industry and put forward three valuable suggestions for YOFC AST that YOFC AST should give priority to academic exchange and scientific popularization, achieve interdisciplinary and innovative development and turn the association into a genuine "home to scientific and technological workers"; earnestly serve the central task of YOFC, make the innovation-driven improvement, give full play to the enthusiasm of core scientific and technological talents in YOFC and put the establishment of academician



workstation into the agenda; scientific and technological workers in YOFC AST should work hand in hand, pioneer to innovate and give full play to the scientific advantage to make contribution to the scientific development of Wuhan and Hubei Province at large.

Li Shiting, Director-general of Science and Technology Innovation Bureau of East Lake High-tech Development Zone, congratulated YOFC on its establishment of association for science and technology and wished YOFC AST to do a good job of AST in line with the articles under the guidance of the provincial and municipal associations for science and technology. Meanwhile, Director-general Li stressed that as science popularization is a lifelong cause, YOFC AST should inherit the scientific and technological innovation culture and strive to be an outstanding and exemplary association of the development zone and Wuhan Association for Science and Technology. The development zone will provide necessary support in terms of logistics and talents to help the scientific research level of YOFC move to a higher level.



长飞印尼光通信公司 举行奠基仪式

□ 长飞印尼光通信公司 孔文韬

早在2017年1月4日，长飞公司就与印尼PT Fiber Optik Teknologi Indonesia在新加坡签署合资协议成立光缆制造公司，日前该项目再传捷报，合资成立的长飞印尼光通信有限公司（PT Yangtze Optics Indonesia）于5月18日在印尼西爪哇省卡拉旺市隆重举行奠基仪式。印尼通信协会主席Kristiono、西爪哇省领导Agus Sokiono，长飞公司第一副总裁Jan Bongaerts，长飞印尼光通信公司印尼方股东Johnny、总经理许定昉，长飞光纤印尼公司总经理陈慧雄等参加了奠基仪式。

长飞印尼光通信公司是长飞公司继2015年1月成立长飞光纤印尼公司



之后在印尼的第二家合资企业，公司总部位于印尼首都雅加达，工厂位于西爪哇省卡拉旺，项目建成之后将会形成年产200万芯公里光缆的生产能力。长飞光纤印尼公司投资为2200万美元，长飞印尼光通信公司投资为1400万美元，至此，长飞公司在印尼投资总额已超过3600万美元。

响应国家“一带一路”倡议，上

市后的长飞公司加速了全球化布局。长飞印尼光通信公司是长飞走向海外的又一里程碑，标志着长飞国际化、全球化战略步伐进一步加快。印尼拥有2.6亿人口，是全球第四大人口国，近年来政局稳定，经济发展平稳。

印尼政府还推出国家宽带计划，大幅推动互联网和宽带发展。可以预见印尼将会迎来光网络建设高峰，光纤光缆市场需求巨大。长飞印尼光通信公司的成立将使长飞公司在印尼拥有完善的光纤光缆产业闭环。新公司将在整合双方股东资源的基础上，立足印尼，辐射周边国家和地区，必将成为印尼和东盟地区最具影响力的光缆制造商。

Cornerstone Laying Ceremony of PT Yangtze Optics Indonesia

□ Kong Wentao from YOI



As early as in January 4, 2017, YOFC and PT Fiber Optik Teknologi Indonesia signed a joint venture agreement in Singapore to set up the cable production company. A few days ago, there was also a piece of good news for the project. The joint venture PT Yangtze Optics Indonesia (hereinafter referred to as "YOI") held its grand cornerstone laying ceremony on May 18 at Karawang City, West Java, Indonesia. Kristiono, Chairman of Indonesian Communication Association, Agus Sokiono, leader of West Java, Jan

Bongaerts, YOFC first Vice President, Johnny, Indonesian Shareholder of YOI, Xu Dingfang, General Manager and Chen Huixiong, General Manager of YOFI etc. attended the cornerstone laying ceremony.

YOI is the second joint venture in Indonesia after YOFI founded by YOFC in January 2015. Headquartered in the capital of Indonesia, Jakarta, YOI has the factory at Karawang City, West Java. After the project is completed, it will have the annual production capacity of 2 million core kilometers cable. YOFI has

an investment of USD 22 million while YOI has an investment of USD 14 million. Therefore, the investment of YOFC in Indonesia totals over USD 36 million.

In order to respond to "the Belt and Road" Initiative, the listed YOFC has accelerated its globalization. YOI is another milestone of YOFC to go overseas, indicating the further development of an international and global YOFC. With a population of 0.26 billion ranking fourth in the world, Indonesia has stable politics and economic development in recent years. The Indonesian government also has launched national broadband plan to largely promote the internet and broadband development. It is predicted that the peak of optical network construction will arrive in Indonesia, whose market demand for fibre and cable is great. The establishment of YOI will make YOFC have complete fibre and cable industrial closed-loop in Indonesia. On the basis of integrating shareholder resources of both parties, the new company will focus on Indonesia, covering adjacent nations and regions and definitely become the most influential cable manufacturer in Indonesia and the ASEAN region.



长飞公司强势中标 2017~2018 年中国联通光缆集采

□ 本刊编辑部

继2016年10月长飞公司以第一名（份额：16.77%）中标中国移动普通光缆集采后，近日，长飞公司在中国联通2017~2018年光纤光缆集采中表现优异，以第一名（份额19.8%）中标带状光缆，第二名（份额11.7%）中标普通光缆。

目前“宽带中国”、“三网融合”、“提速降费”等政策不断落地，尤其是《信息基础设施重大工程建设三年行动方案》提出2016~2018年信息基础设施将投资1.2万亿元，推动中国信息化基础建设持续升温。2016年三大运营商大力推进4G网络基础设施建设，也极大地提高了对光纤光缆的需求。

作为全球最大的预制棒、光纤和光缆供应商，长飞公司充分抓住市场机遇，通过自主研发与技术引进，已成为全球唯一同时掌握世界三大主流预制棒生产工艺的企业，构建了领先的预制棒供应能力。“长飞制造，质量先行”，公司始终将质量

视为立企之本，产品质量和品牌广受认同，连续在运营商集采中取得骄人战绩，这些成绩的取得离不开

客户的信赖与支持。在2016年度业绩中，长飞更是以可喜成绩再创公司业绩新高。在光纤光缆市场短缺情况下，长飞公司将充分发挥供给优势、提高产品质量，全力支持中国通信网络与信息化建设。



YOFC Won the Bidding of China Unicom's Central Purchase of Optical Fibre in 2017-2018 with Good Result

□ The Editorial

Since won the bidding of China Mobile's central purchase of ordinary optical cable as No.1 (with a share of 16.77%) in October, 2016, YOFC again won the bidding of China Unicom's central purchase of optical fibre and cable in 2017-2018 with good result recently. Specifically, YOFC won the bidding of ribbon cable as No.1 (with a share of 19.8%) and won the bidding of ordinary optical cable as No.2 (with a share of 11.7%).

With the continuous implementation of such policies as Broadband China, Integration of Three Networks, and Faster and More Affordable Internet Connection, especially an investment of 1.2 trillion in information infrastructure in 2016-2018 put forward in Three-Year Action Plan for Major Projects of Information Infrastructure Construction, China's information infrastructure construction is pushed to develop continuously. In addition, infrastructure construction of 4G network vigorously promoted by three operators (namely, China Mobile, China Unicom, and China Telecom) in 2016 also greatly raises

people's demands for optical fibres and cables.

As the largest supplier of optical preform, fibre and cable in the world, YOFC has become the only enterprise in the world which masters all of the three mainstream preform production processes in the world and has mastered leading preform supply ability by taking full advantage of the market opportunity and taking an active part in independent R&D and technology import. Following the policy of YOFC Manufacturing, Quality First, YOFC always regards quality as the foundation of the enterprise. As a result, YOFC products and brands are widely recognized with excellent quality, and YOFC makes impressive achievements in operators' central purchase under customer's trust and support. In 2016, YOFC even brought its results to new heights with better results. Facing the situation where the market is short of optical fibres and cables, YOFC will give full support to China's communication network and information construction by making full use of its supply advantage and improving the quality of its products.

湖北省委书记蒋超良一行 视察长飞潜江科技园

□ 战略中心 曾云飞



5月16日，湖北省委书记蒋超良一行来到长飞潜江科技园视察。长飞公司执行董事兼总裁庄丹、长飞公司荣誉副总裁张穆、长飞公司技术总监兼长飞潜江公司总经理罗杰出席接待。

庄总对蒋书记一行的到来表示热烈欢迎，并向来访领导

介绍了长飞潜江科技园的发展情况。庄总表示，长飞潜江科技园是长飞公司在湖北省、潜江市政府大力支持下，在全球范围内整合最领先的产业链资源，构建智能制造，发展循环经济和绿色制造的有力探索，为全球光纤光缆行业树立了新的标杆。蒋书记深入预制棒及光纤制造车间察看生产情况，充分肯定了长飞公司的发展和长飞潜江科技园的建设，得知从制造设备到操作软件均为长飞公司自主研发，蒋书记鼓励长飞要进一步加强技术创新，让更多“中国智造”走向世界。

长飞公司将紧抓市场机遇，整合优势资源，响应国家“一带一路”倡议，立足中国，辐射全球，引领世界光纤光缆智能制造发展，将科技园打造成为全球范围内最具影响力的光纤光缆生产和研发基地。

Secretary of Hubei Provincial Party Committee Jiang Chaoliang and His Company Visited YOFC Qianjiang High-tech Industrial Park

□ Zeng Yunfei from Strategic Center

On 16 May, secretary of Hubei Provincial Party Committee Jiang Chaoliang and his company visited YOFC Qianjiang High-tech Industrial Park. Executive director and president of YOFC Zhuang Dan, honorary vice president of YOFC Zhang Mu and technical director of YOFC and general manager of YOFC Qianjiang Company Luo Jie received them.

Mr. Zhuang extended his warm welcome to their visit, and then introduced the development and status of YOFC Qianjiang High-tech Industrial Park. Mr. Zhuang said, YOFC Qianjiang High-tech Industrial Park is an experiment of YOFC to integrate the most advanced industrial chain resources around the world, establish intelligent manufacturing, develop recycling economy and green manufacturing, which gained great support from Hubei Provincial Government and Qianjiang Municipal Government. It established a new benchmark for the optical fibre and cable

industry in the world. Secretary Jiang inspected the production status of the preform and optical fibre manufacturing workshops, and fully recognized the development of YOFC and the construction of YOFC Qianjiang High-tech Industrial Park. After knowing that manufacturing equipment and operation software are all self-developed by YOFC, Secretary Jiang encouraged YOFC to continue to enhance technological innovation, and let "Intelligently made in China" go global.

YOFC will grasp market opportunities, integrate advantageous resources, respond to the initiative of the "Belt and Road", be rooted in China and exert influence over the world, and lead the development of optical fibre and cable intelligent manufacturing in the world. It will build the technology park into the most influential optical fibre and cable production and R&D base in the world.

长飞公司召开 第五届光缆技术质量交流会

□ 长飞沈阳公司 何小琼



6月8日，长飞公司第五届光缆技术质量交流会在长飞沈阳公司召开，铁岭县县长孙永东，铁岭县工业园区主任王大民，长飞公

司副总裁闫长鹏、市场及战略总监江志康、运营管理中心副总经理钮国辉以及各子分公司总经理和质量负责人参加了本次会议。

会上各参会人员针对最近半年公司在光缆技术质量方面取得的成绩与出现的问题、光缆新产品以及光缆标准与专利等进行探讨和交流。孙永东县长在会上表示，铁岭县政府将一如既往支持长飞公司的发展，也相信长飞公司凭借良好的质量和先进的技术能取得更好的成绩。闫总对铁岭县政府的支持表示感谢，并鼓励大家利用好质量交流会这个平台，毫无保留地交流心得，以此促进质量、技术的共同提高，为即将到来的5G做好市场准备。

长飞公司一贯重视质量，长飞沈阳公司一直以来也将质量视为产品的根本，通过此次技术质量交流会的召开，长飞沈阳公司将进一步严把质量关，真正践行公司“精益求精，品质卓越”的质量观。

YOFC Held the 5th of Optical Cable Technology Quality Meeting

□ He Xiaoqiong from YOFC (Shenyang)

On 8 June, the 5th of Optical Cables Technology Quality Communication Meeting of YOFC Company was held in YOFC(Shenyang). County magistrate of Tieling county Sun Yongdong, director of the industrial park Wang Damin, vice president of the company Yan Changkun, market and strategic director Jiang Zhikang, vice general manager of the Operation Management Center Niu Guohui and general managers and quality personnel of subsidiaries attended the meeting.

Meeting participants discussed achievements made by the company in optical cable technology quality and problems found in the past half year, optical cable new products, as well as standards and patents of optical cables. County magistrate Sun Yongdong said in the meeting that Tieling county government will always support the development of YOFC. It is believed that YOFC can achieve better results with good quality and advanced technology. Mr. Yan expressed his gratitude to the support of the Tieling county government and encouraged everyone to make good use of the quality meeting, exchange ideas with each other without reservation, so as to promote



quality and technology and make market preparation for the upcoming 5G.

YOFC always attaches importance to quality. YOFC(Shenyang)also has considered quality as the basis of products. Through the holding of the technology quality meeting, YOFC(Shenyang)will further control the quality and fulfill the quality value of the company of "Keep improving, quality excellence".

长飞公司 气吹微缆实现高速生产

□ 研发中心 蔡晶

近日，长飞公司高速二套生产线投入使用，气吹微缆二次套塑工艺生产速度已达800m/min，生产效率较之前提高了300%，达到世界领先水平。

气吹微缆以其优异的综合性能和独特的敷设方式在国际市场得到广泛应用。随着光通信行业的迅猛发展，气吹微缆的生产效率和产能已难以满足客户日益增长的需求。由于气吹微缆套管直径小、壁厚薄，二次套塑的生产速度已成为制约气吹微缆高效稳定生产的瓶颈。长飞公司引进高端进口设备，经过研发人员的调试和改造，实现了精准的设备控制和稳定的加工

工艺，将微缆二次套塑生产速度提高到800m/min，有效解决了气吹微缆产能紧张的难题。

从2005年开始，长飞公司在国际上首次提出塑料管结构气吹微缆技术，逐步在国际上得到认可和应用。经过多年的潜心研究和探索，长飞已具备了世界一流的气吹微管微缆整体方案设计能力和相关全套产品的供货能力，并且拥有不少在长途干线、城市环网、局间中继、管道扩容和FTTx等场景成功应用的案例。作为光纤光缆行业的龙头企业，长飞公司不断推进光纤光缆的技术创新，并积极开拓新市场，将持续保持核心技术的领先。

YOFC Realized High-speed Production of Air-blowing Micro Cables

□ Cai Jing from R&D Center



Recently, YOFC put its high-speed secondary coating production line into use. By using the secondary coating process, this production line can provide a production speed of air-blowing micro cables as high as 800m/min. This enables the production efficiency to rise by 300% and reach the leading level in the world.

Thanks to its excellent overall performance and unique laying mode, air-blowing micro cable is widely used in the international market. With rapid development of the optical communication industry, the production efficiency and capacity of air-blowing micro cable have been difficult to meet the customers' increasing requirements. As the sleeve of air-blowing micro cable features small diameter and thin wall, the production

speed of secondary coating has become the bottleneck which restricts efficient and stable production of air-blowing micro cables. To solve this problem, YOFC introduces high-end import devices, which are then debugged and modified, so as to realize precise device control and stable processing technology. As a result, the production speed of secondary coating of micro cables is raised to 800m/min, and the problem of tight capacity in air-blowing micro cables is solved effectively.

Since being put forward by YOFC in the world in 2005 for the first time, the technology of air-blowing micro cables in structure of plastic pipe has been gradually recognized and applied in the world. After many years' painstaking research and exploration, YOFC has mastered the capability of designing world-class overall solutions of air-blowing micro tube and micro cable as well as the supply ability of the related full-range products. In addition, YOFC also has these solutions and products successfully applied in such scenarios as long-distance trunk, metropolitan ring network, interoffice trunk, pipe expansion, and FTTx. As the leader of the optical fibre and cable market, YOFC will keep its leader position in core technologies by continuous innovation in the optical fibre and cable technologies and active exploration of new markets.

长飞沈阳公司爱心基金会 组织“敬老院送温暖”公益活动

□ 长飞沈阳公司 何小琼

长飞沈阳公司爱心基金会成立于2016年底，目前该基金会的款项均来源于个人捐款，其中长飞沈阳公司总经理刘国峰、技术总监杨笛雨等人把铁岭县政府对其个人奖励的奖金全部捐赠给基金会，基金会的款项将专用于社会上需要帮助的群体。



在端午节期间，长飞沈阳公司爱心基金会组

织了“敬老院送温暖”公益活动，公司员工在公司领导带领下同当地政府一起走进了铁岭县敬老养老服务中心，为百余位老人送去了米、面、油等生活必需品，并与老人交流谈心。在了解到敬老院的日常经营和老人们的生活水平后，长飞沈阳公司爱心基金会决定将铁岭县敬老养老服务中心定为定点爱心帮扶单位，将定期对敬老院进行帮扶。

近年来长飞沈阳公司所在的铁岭县老龄化趋势明显，关爱老年人是当地政府也是社会的呼声。作为全球领先的光纤光缆企业，长飞公司一贯重视社会责任，长飞沈阳公司也积极秉承集团社会责任理念，将对社会的关爱纳入日常工作之中，做到“责任共筑 微笑共赢”。

YOFC(Shenyang) Love Foundation Organized the Public Service Activity of “Sending Warmth to Nursing Homes”

□ He Xiaoqiong from YOFC(Shenyang)

Founded in the end of 2016, YOFC(Shenyang), Love Foundation collects all of the fund from personal donation. Among them, Liu Guofeng, General Manager of YOFC(Shenyang) and Yang Diyu, Technical Director, etc. have donated all the personal bonus awarded by Tieling County Government to the Foundation. The fund of the Foundation will help those groups in need in the society.

During the Dragon Boat Festival, YOFC(Shenyang) Love Foundation has organized the public service activity of “sending warmth to nursing homes”. Led by leaders, company employees, along with the local government, visited the Tieling County Elderly Care Service Center, sent hundreds of elderly people life necessities such as rice, noodle and oil, and conversed with them. After understanding the daily operation and living standard of the nursing home, YOFC(Shenyang) Love Foundation decided to make the Tieling County Elderly Care Service Center as its fixed

assistance target and will continue to help and support it regularly.

In recent years, with an increasing number of

aged people in Tieling County where YOFC(Shenyang) is located, the local government and the society call for the care for elderly people. As a world's leading fibre and cable enterprise, YOFC has consistently been emphasizing social responsibility. YOFC(Shenyang) also actively adheres to the concept of social responsibility, integrates the care for the society with its daily work and achieves the “shared responsibility for a win-win situation”.



南非财政部长一行 访问长飞非洲公司

□ 长飞非洲公司 彭国泰

5月2日，“世界经济论坛”在南非德班隆重举行，论坛参会代表南非财政部长马鲁西·吉加巴，南非夸祖鲁纳塔尔省政府负责经济发展、旅游和环保事务的执行委员西和乐·齐卡拉拉，德班市市长桑黛尔·古麦蒂以及多位政府部门领导和重要嘉宾来到长飞非洲公司开展调研考察工作。来访嘉宾参观了长飞非洲公司以先进理念打造的光缆生产车间，调研了针对南非当地技术条件所引进的最先进的光缆生产设备和生产技术。

响应国家“一带一路”倡议，2016年3月，长飞公司与Mustek有限公司签署长飞非洲公司项目合资协议，同年12月，长飞非洲公司竣工。秉承长飞总部的企业发展方向，长飞非洲公司从国内引进最先进的光缆生产装备和技术，生产并提供在南非当地因技术瓶颈而无法制造的部分光缆产品。未来，长飞非洲公司将立足南非，辐射整个非洲，力争成为南非乃至



非洲地区最具影响力的光纤光缆供应商。

光纤技术具备高速度的互联网接入能力，为南非当地企业和个人带来新的经济发展机会，也为创业者打造了一个蓬勃商业生态系统，便于企业向市场提供新的产品和服务。

South African Finance Minister visited YOA

□ Peng Guotai from YOA

On May 2, the “World Economic Forum” was ceremoniously held in Durban, South Africa. As part of the forum, Mr. Malusi Gigaba, the Minister of Finance of South Africa, Mr. Shihle Zikalala, MEC for Economic Development, Tourism and Environmental Affairs of Kwazulu Natal, Ms. Zandile Gumede, Mayor of Durban and a number of government department leaders and important guests paid a visit to YOA Cable to conduct the investigation. The guests have visited the optical cable production plant designed by YOA Cable with advanced concept and investigated the most advanced introduced optical cable manufacturing equipment and technologies based on the local technology condition in South Africa.

In line with the national “Belt and Road” Initiative, YOFC and Mustek Limited signed an agreement of YOA

Cable joint venture in March, 2016. In December, 2016, YOA Cable completed its construction. Following the development pathway of the headquarters, YOA Cable has introduced the most advanced optical cable manufacturing equipment and technologies from China to make and supply some optical cables that cannot be made in South Africa due to technical bottleneck. In the future, YOA Cable will center on South Africa and cover all over Africa to strive to become the most influential optical fibre and cable supplier in South Africa and Africa at large.

With an ability to deliver high-speed internet access, the optical fibre technology has brought new economic opportunities for the local enterprises and individuals in South Africa and enabled a thriving business ecosystem for startups to provide new goods and services for the market.

长飞光纤印尼公司产品 出口东盟国家

□ 长飞光纤印尼公司 Vivi



近年来，随着高速光纤网络在东盟国家的规模部署，东盟地区光纤光缆的需求显著增长。作为在印尼和东盟国家的唯一一家光纤制造公司，长飞光纤印尼公司处于东盟光纤和光缆业务金字塔的顶峰位置，我们光纤业务的发展见证着当地通信的迅速发展。

截至2017年第二季度，长飞光纤印尼公司已成功为印尼、越南等国家提供超过一百万公里光纤，公司不仅能生产传统光纤产品，还能生产新型产品，这让我们更有信心把光纤出口到东盟其他国家，以此扩大海外市场，增加公司利润。

未来，长飞光纤印尼公司将不断为区域经济发展做出更大贡献，让每个人都能享受光纤技术带来的自由与快乐。

YOFI Exported Fibre to Asean Country

□ Vivi from YOFI

With large-scale deployment of gigabit network in ASEAN, the demand for optical fibre and cable grows significantly. YOFI as the first and only optical fibre manufacturing company in Indonesia and ASEAN region, she is staying at the peak of the pyramid of the optical fibre and cable industry, and the optical fibre industry witnessed rapid development of communication.

YOFI has successfully supplied fibre over 1,000,000 KM for countries such as Indonesia and Vietnam till second quarter of 2017. We can supply not only produce traditional but also new product, which encourages YOFI to enter export business to another ASEAN countries. By doing export, YOFI is confident she will inevitably lead to increase profit and expand by reaching larger market abroad.

YOFI will continue to make more contributions to the economic development of these regions and empower the people



to truly enjoy the happiness and benefits that fiber communication brings about.

长飞公司与中国联通联合项目 荣获中国电子学会科学技术奖一等奖

□ 国家重点实验室



4月27日，第十二届中国电子信息科学技术年会暨2016年度中国电子学会科技奖励大会隆重召开。由长飞公司和中国联通联合完成的“超低衰减和大有有效面积光纤及其在下一代干线通信网络中的应用示范”项目荣获中国电子学会科学技术奖一等奖。

该项目立足于国内干线光缆需要换代升级的历史机遇，以超低衰减大有有效面积光纤的技术和市场需求为导向，以等离子体气相沉积工艺为基础，系统性考虑了产品和制备技术的关联性，从制备技术、剖面设计、规模化生产、应用方面进行了全面创新。原创性地开发了等离子体气相沉积法制备超低衰减光纤的技术方案，打造了国内唯一具有全套自主知识产权的超低衰减光纤制备工艺平台。该项目通过了湖北省科技成果鉴定，相关专家一致认定长飞超低衰减大有有效面积光纤产品达到国际先进水平。

在应用方面，中国联通和长飞公司开创性地完成了两条使用大有有效面积G.654.E光纤的陆地光缆的实际部署，开创了超低衰减大有有效面积光纤陆地应用的先河，相关线路在链路衰减水平和有效面积性能上较常规光缆有巨大提高。

Joint Project of YOFC and China Unicom Won the First Prize of Chinese Institute of Electronics Scientific and Technological Award

□ By the State Key Laboratory

On 27 April, the 12th China Electronic Information Technology Conference cum 2016 Chinese Institute of Electronics Technology Awarding Meeting was held. "Ultra low loss and large effective area optical fibre and its application demonstration in the next generation of the trunk communication network" project, which was jointly completed by YOFC and China Unicom, won the first prize of Chinese Institute of Electronics Scientific and Technological Award.

As for this project, leveraging on historic opportunities of replacement and upgrading of domestic trunk optical cables, oriented by technology and market demand for ultra low loss and large effective area fibre, based on gas phase plasma deposit craftsmanship, systematically considering relevance of products and fabrication technology, YOFC and China Unicom made comprehensive innovation in aspects of fabrication technology,

section design, scale production and application. They innovatively developed the technology scheme of fabrication of ultra low loss fibre with gas phase plasma deposit method and established China's only ultra low loss fibre fabrication craftsmanship platform with a full set of proprietary intellectual property rights. The project passed technology achievements identification in Hubei Province. Experts agreed that YOFC's ultra-low loss and large effective area fibre products have reached international advanced level.

In aspect of application, China Unicom and YOFC innovatively completed deployment of two large effective area G.654.E optical fibres on land, symbolizing the beginning of the application of ultra low loss and large effective area fibre on land. Great improvement was made in link loss level and effective area performance of relevant lines, compared to conventional optical cables.

长飞公司先进光纤及预制棒制备平台 关键技术项目荣获湖北省科技进步二等奖

□ 国家重点实验室



近日，湖北省科学技术奖励大会在武汉召开，大会隆重表彰了为湖北科技事业做出贡献的集体和个人。湖北省省委书记、省人大常委会

主任蒋超良出席大会，并为2016年度省科学技术突出贡献奖获得者颁奖；省委副书记、省长王晓东出席会议并讲话。在本次奖励大会上，长飞公司《先进光纤及预制棒制备平台关键技术开发及应用》项目荣获湖北省科技进步奖二等奖。

该获奖项目围绕高性能光纤及预制棒制备平台所需的关键技术进行重点攻关，在理论分析、设计方法、工程实现等多方面进行了全面创新，形成了系统性的制备平台技术开发体系；解决了高速拉丝精确控制、大尺寸预制棒高速沉积等一系列技术难点，实现了具有自主知识产权的光纤及预制棒关键制备技术及设备开发、集成和应用。

该项目开发的关键设备技术和制备技术达到了国际领先水平，并形成了规模化应用。目前已向全球同行业输出了300余套设备，由该项目开发的设备平台制备的光纤占国内总产能的三分之一，不仅满足了公司自身发展的需要，而且向全行业进行了工程应用推广，为光纤行业整体技术的进步做出了突出贡献。

Key Technology Project of Advanced Optical Fibre and Preform Fabrication Platform of YOFC Awarded the Second Prize of Hubei Provincial Technology Advancement Award

□ By the state key Laboratory

In recent days, Hubei Science and Technology Awarding Meeting was held in Wuhan. The meeting commended groups and individuals that made prominent contribution to the technology industry in Hubei Province. Secretary of Hubei Provincial Party Committee and director of The Standing Committee of Provincial People's Congress Jiang Chaoliang attended the meeting and granted awards to laureates of 2016 Provincial Science and Technology Prominent Contribution Awards. Vice secretary of the provincial party committee and governor Wang Xiaodong attended the meeting and made a speech. At the awarding meeting, the key technology development and application project of advanced optical fibre and preform fabrication platform of YOFC was awarded the second prize of Hubei Provincial Technology Advancement Award.

As for this award winning project, major breakthrough was made in key technologies needed in high performance optical fibre and preform fabrication platform. Comprehensive

innovation was made in many fields such as theoretical analysis, design methods, and engineering implementation. As a result, a systematic fabrication platform technology development system has taken shape. It solved a series of technology difficulties such as high speed wiredrawing accuracy control and big size preform high speed deposit, and realized development, integration and application of optical fibre and preform key fabrication technology and equipment with proprietary intellectual property rights. In the project development, the technology of key equipment and fabrication technology reached international advanced standard.

Meanwhile, more than 300 sets of equipment were exported to peers in the world. Optical fibres fabricated by equipment platforms developed in the project account for one third of the total production capacity in China, not only meeting demand for self-development of the company, but also making big contribution to overall technical progress of the optical fibre industry.

长飞公司首席技师钟升 荣膺武汉市“大城工匠”称号

□ 制造中心 陈锋

2016年武汉市“大城工匠”选树结果于2017年4月20日揭晓，29名在本职工作中做出卓越贡献的一线职工被授予武汉“大城工匠”荣誉称号。长飞公司首席技师钟升喜获武汉市首届“大城工匠”殊荣。

长飞公司首席技师钟升从事技术工作近30年，他刻苦钻研专业知识和技术，在光缆设备维修工作中掌握了各类型生产线的工作原理和维修技能，并取得了197项技术革新成果。其主导项目率先在国内光缆制造业迈出了自主创新整体改造大型进口生产线电控系统的第一步，技术革新成果应用于光缆制造等生产实践中，取得增产降本的重大效益。在2011年，他获得了武汉市总工会颁发的“武汉五一劳动奖章”以及武汉市政府颁发的“武汉市技术能手”证书，并于2013年荣获“武汉市首席技师”荣誉称号。正如组委会对钟升的评价一样：

“30年精耕于平凡，刻苦钻研，潜心研究；30年贡献于不平凡，打响通信行业自主创新整体改造大型进口设备第一枪”。



武汉拥有深厚的工业文明底蕴，是中国近现代工业的重要发祥地之一，见证了民族复兴的百年追梦历程。以“汉阳造”为代表的武汉制造名噪一时、蜚声中外，“工匠精神”在这片土地上开花结果。

Principal Technical Officer of YOFC Zhong Sheng Awarded the Title of "Craftsmen of City" in Wuhan

□ Chen Feng from Manufacturing Center

In 2016, the election result of "Craftsmen of City" was unveiled on 20 April 2017 in Wuhan City. 29 employees who made excellent contribution in their work were awarded honorary titles of "Craftsmen of City". Principal technical officer of YOFC Zhong Sheng was awarded the title of "Craftsmen of City" of the first session in Wuhan City.

Principal technical officer of YOFC Zhong Sheng has worked for 30 years in the technology field. He has been industriously studying professional knowledge and technology. He grasped operating principle and maintenance skills of various kinds of production lines in the maintenance of optical cables equipment and made 197 technological innovation achievements. The projects undertaken by him include China's first self-innovation overall renovation in large-scale imported production line electric control system in the optical cable manufacturing industry. The technological innovation achievements were applied in production practice in optical cable manufacturing and achieved significant results in production increase and cost

reduction. In 2011, he obtained "Wuhan Labour Day Holidays Labour Award" granted by All Wuhan Federation of Trade Unions and the title of "Wuhan Technology Experts" certificate granted by Wuhan Municipal Government, and obtained the honorary title of "Wuhan Principal Technical Officer" in 2013. As the organizing committee appraised Zhong Sheng, "He has worked in a meticulous, humble and assiduous way for 30 years. However, his contribution in the past 30 years is extraordinary. He is the pioneer in self-innovation overall renovation in large-scale imported equipment in the communication industry."

Wuhan has profound industrial culture. As one of the important birthplaces of Chinese modern and contemporary industry, it has witnessed the dream of national rejuvenation in the past one hundred years. The products made in Wuhan, especially rifles made in Hanyang, enjoy quite a reputation in China and foreign countries. "Craftsmanship spirit" achieved fruitful results on this land.

IEC SC86A

光纤光缆标准工作组会议在京召开

□ 研发中心 李婧



由长飞公司承办的IEC SC86A标准工作组会议于2017年4月24~27日在北京召开。长飞公司执行董事兼总裁庄丹博士出席了此次会议。

来自全球10多个国家的40多位技术专家参加了本次会议，

会议讨论内容涉及多个光纤光缆产品特性标准和测试方法标准的制修订。长飞公司研发中心副总经理熊壮、研发中心检测实验室经理李婧同为IEC SC86A的专家组成员，长期跟踪IEC的标准化活动，并牵头承担了多项IEC标准的修订工作。作为光纤光缆行业的领军企业，长飞公司致力于为客户提供标准化、高质量的产品和解决方案，以标准助力创新和发展。同时，长飞也愿与行业内的企业继续深入标准合作，加强交流，共同完善光纤光缆标准体系。

IEC是国际电工委员会（International Electrotechnical Commission）的缩写，正式成立于1906年，是世界上成立最早的国际标准化机构。IEC SC86A是专门制修订光纤光缆标准的分技术委员会，所负责制定的60793和60794系列标准在光纤光缆行业被广泛参考和使用。

IEC SC86A Optical Fibre and Cable Standards Work Group Meeting was Held in Beijing

□ Li Jing from R&D Center

The IEC SC86A Standards Work Group Meeting organized by YOFC was held in Beijing from 24 April to 27 April 2017. Executive director and president of YOFC doctor Zhuang Dan attended the meeting.

More than 40 technology experts from more than 10 countries in the world attended the meeting. The content of the meeting includes discussing formulation and revision of certain optical fibre and cable products characteristics standards and test method standards. Vice general manager of the R&D Center of YOFC Xiong Zhuang and manager of the Testing Laboratory of the R&D Center Li Jing are members of expert groups of IEC SC86A. They have been tracking standardization activities of IEC for a long time, and are responsible persons for certain IEC standards revision work. As a leading enterprise in the optical fibre and cable industry, YOFC is committed to providing customers with standardized, high quality products

and solutions and giving impetus to innovation and development with standards. Meanwhile, YOFC wishes to intensify standards cooperation and communication with enterprises in the industry, and work together to optimize optical fibre and cable standards system.

IEC is the abbreviation of International Electrotechnical Commission. Founded in 1906, it is the earliest international standardization institute in the world. IEC SC86A is a technology subcommittee specialized in revising optical fibre and cable standards. 60793 and 60794 series standards formulated by it are widely adopted in the optical fibre and cable industry.



长飞公司应邀出席中国-加拿大合作论坛

□ 国家重点实验室

5月15日，由中国驻多伦多总领事馆和加拿大安大略省共同举办的“第六届中国-加拿大（安大略）研究与创新合作论坛”隆重召开。长飞公司国家重点实验室应邀出席了本次论坛。同时，还参加了新材料及其光电应用技术项目对接活动和由安省卓越中心（OCE）主办的“Discovery”大型高新技术成果展活动。

5月16日，长飞国重执行副主任熊良明应邀作为中方企业代表，参加了圆桌论坛，重点宣传和推荐了长飞与国重及所属地湖北武汉的技术创新与产业发展情况，并积极倡导加强双边技术与产业交流，推动创新合作。会后，公司与会代表应邀到多伦多大学作技术交流，重点调研了新型光电子材料及其应用技术及初创项目情况；就长飞国重与多伦多大学光电材料与应用实验室的协同创新机制达成共识，并签署了相关协议。

在论坛前夕，中国驻多伦多总领事馆科技参赞沈建磊接见了长飞代表团，沈参赞高度赞赏了长飞近年来响应国家倡议，在“一

带一路”沿线国家、地区实施的重要产业布局 and 战略举措。论坛后不久，公司技术总监

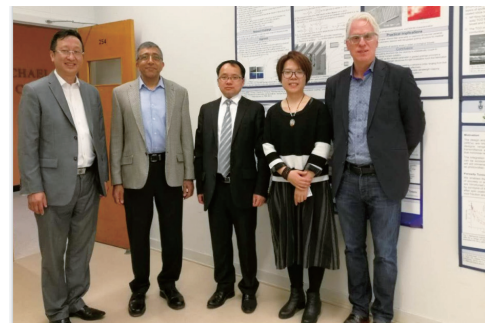

兼国重主任罗杰等在武汉接见了加拿大科学院院士、渥太华大学鲍教授一行，双方就新型光纤设计、特种光纤的新型应用及产品技术孵化等开展了深入探讨，并就下一步技术合作事宜，达成了初步共识；双方前期科技合作创新成果，已发表在Optics Letters、Optics Express等国际著名学术期刊上。

YOFC was Invited to Attend China-Canada Collaboration Forum

□ By The State Key Laboratory

On May 15, the “6th China-Canada (Ontario) Research & Innovation Collaboration Forum” co-hosted by Consulate-general of the People’s Republic of China in Toronto and the Ontario Ministry of Research and Innovation was ceremoniously held. YOFC State Key Laboratory was invited to attend the forum and the matchmaking activities of new materials and their optoelectronic application technology projects.

Meanwhile, YOFC delegation also attended the “Discovery” large-scale high-tech achievement exhibition hosted by the Ontario Centres of Excellence (OCE). On May 16, as the Chinese enterprise delegate, Xiong Liangming, Deputy Executive Director of YOFC State Key Laboratory, was invited to attend the “Discovery” Panel Discussion to focus on publicity and recommendation of technical innovation and industrial development of YOFC, State Key Laboratory and Hubei Wuhan at large, actively advocate the improvement in bilateral technical and industrial communication and promote the innovative collaboration. After the event, YOFC delegates were invited to go to University of Toronto for technical investigation and cooperative exchange, with a focus on investigation of new-type optoelectronic material and its application technology and start-up

projects; reached a consensus on establishment of a collaborative innovation mechanism between YOFC State Key Laboratory and Optoelectronic Material and Application Laboratory of University of Toronto and signed relevant agreement.

Before China-Canada Collaboration Forum, Mr. Shen Jianlei, Science and Technology Counselor of Consulate-general of the People’s Republic of China in Toronto, met with the YOFC delegation, highly appreciating YOFC in responding to the national initiative in recent years and carrying out key industrial layout and strategic initiatives in countries or regions along the Belt and Road. After the forum, the group of Luo Jie, YOFC Technical Director & Director of YOFC State Key Laboratory, interviewed in Wuhan with the group of Professor Bao, an academican of National Research Council of Canada and a professor in University of Ottawa. Both sides had an in-depth discussion of new-type fibre design, new application of special fibre and product technology incubation etc. and reached the initial consensus in terms of technical cooperation of the next step. Recently, the initial achievements of scientific and technological cooperation and innovation of both sides have been published in the world-famous academic journals such as Optics Letters and Optics Express.

长飞公司 亮相 2017 香港世界数据中心展

□ 长飞智连公司 姚鹏

5月24~25日，香港世界数据中心展在中国香港会议展览中心隆重举行，吸引了全球数据中心从业者的目光，7000多名高端专业人士在此交流最新见解、研讨建设方案、建立伙伴关系，共同推动低成本高效率的数据中心运作。长飞公司在本次展会上集中展示了数据中心预端接解决方案和宽带多模OM5弯曲不敏感光纤的未来应用。

光纤是通信数据传输的关键载体，在数据大爆发的时代，长飞公司秉承“智慧联接 美好生活”的使命，坚守“客户 责任 创新 共赢”的价值观，为全球客户提供优质的光纤连接产品和

综合解决方案，助力构建支撑智慧城市、智慧社区、智能交通等发展的智能网络，与客户一起致力于实现智慧联接，共创万物互联世界的美好生活。

亚洲地区是未来云计算、数据中心、智能物联网解决方案市场的集中增长点，香港世界数据中心展是当今亚洲地区国际云技术设备、大数据中心技术设备、云安全及智能物联网技术设备贸易展，同时集行业会议、系列讲座、传媒热点以及新产品的发布平台于一身，将数据中心的真实价值最大程度呈献给参展参会的企业代表及广大客户。

YOFC Attended 2017 Data Center World Hong Kong

□ Yao Peng from YOFC Connectivity



From 24 May to 25 May, Data Center World Hong Kong was held at Hong Kong Convention and Exhibition Center. The exhibition attracted data center practitioners around the world. 7,000 high-end professionals exchanged their latest insights, discussed construction plans, established partnership, and jointly promoted the operation of the data center with low-cost and high efficiency. At the exhibition, YOFC showed the future application of data center MPO solution and wideband and multimode OM5 bending insensitive optical fibres.

Optical fibre is a key carrier for communication and data transmission. At the age of data explosion, adhering to the mission of "Smart Link, Better Life", and the concept of "Client Focus, Accountability, Innovation, Stakeholder Benefits", YOFC provides customers worldwide with high quality optical fibre connection products and comprehensive solutions, gives impetus to the construction of the intelligent network, which supports the development of intelligent cities, intelligent communities, and intelligent traffic. It works together with customers to realize smart links, and create a better life of Internet of Everything.

Asia is the main growth point of cloud computing, data center, intelligent Internet of Things solution market in the future. At present, Data Center World Hong Kong is an international cloud technology equipment, big data center technology equipment, cloud safety and intelligent Internet of Things technology equipment trading exhibition in Asia. It is also a platform for industrial meeting, series of lectures, media hot spots release and launch of new products, and exhibits the true value of the data center to enterprise representatives and mass customers attending the exhibition.



筑梦“狮城”

长飞公司闪耀亚洲国际通信与信息展

□ 战略中心 曾云飞

5月，“狮城”新加坡气温如火，同样火热的还有位于新加坡滨海湾金沙会展中心的“2017年亚洲国际通信与信息技术展”现场。长飞公司携新型光纤与隐形缆室内布线、4G布线、数据中心布线、微管微缆、有源光缆及应用方案等多种线缆解决方案精彩亮相。

超低衰减大有效面积光纤和宽带多模光纤是通信光纤皇冠上的两颗明珠，也是长飞展台上最大的亮点，这两款产品的展出体现了长飞公司在单模和多模光纤产品线世界领先的技术实力，吸引了来自新加坡、菲律宾、印尼、泰国、马来西亚等国

家的客户前来参观、洽谈，现场气氛活跃。

新加坡是“一带一路”中“丝绸之路经济带”东南亚区域的重要节点，作为全球领先的光纤预制棒、光纤与光缆供应商，长飞公司积极响应国家“一带一路”倡议，加速了全球化布局。2016年长飞公司已成为全球最大的光纤预制棒、光纤与光缆供应商，面向未来，长飞公司将推动棒纤缆业务内涵增长，强化技术创新与智能制造，深化实施国际化战略，积极探索多元化发展，提升资本运营，为股东和客户创造更高价值，致力于发展成为全球智慧联接与信息传输的领导者。

Build Our Dream in "Lion City" YOFC Attended CommunicAsia

□ Zeng Yunfei from Strategic Center

In May, "Lion City" Singapore is very hot in temperature. The CommunicAsia 2017, which was held at Marina Bay Sands Exhibition & Convention Centre of Singapore, was thronged with people. YOFC attended the exhibition bringing with it new type optical fibres, invisible cable interior wiring, 4G wiring, data center wiring, micro tubes and micro fibres, active optical cables and applications and other wiring and cable solutions.

The ultra low loss and large effective area fibre and wideband multimode fibre are two crown jewels of telecommunication optical fiber. The exhibition of two products embodied the world-leading technology strength of single-mode and multimode fibre products line of YOFC. Customers from Singapore, the Philippines, Indonesia, Thailand and Malaysia came to the booth to discuss businesses. The atmosphere at the site was animated.

Singapore is an important node of the "Silk Road Economic Belt" of the "Belt and Road" in Southeast Asia Area. As the world's leading optical fibre preforms, optical fibres and optical cables supplier, responding to the initiative of the "Belt and Road", YOFC facilitated the global strategy after the listing. In 2016, YOFC became the world's largest supplier of optical fibre preforms, optical fibre and optical cables. Looking into the future, the company will push forward intensive growth of optical fibre preforms, optical fibre and optical cables businesses, enhance technological innovation and intelligent manufacturing, intensify international strategy, actively exploit diversified development, improve capital operation, create more value for shareholders and customers, and strive to develop itself into the leader in information transmission and smart links in the world.

长飞公司 参加 2017 FTTH 亚太会议

□ 战略中心 米步明



亚太地区通信行业盛会——FTTH亚太会议（FTTH Council Asia-Pacific Conference）于4月25~26日在印度新德里隆重召开。会议聚集了来自政府、电信运营商、网络工程集成商、制

造商等的近600位代表，共同探讨了印度和亚太地区的FTTH建设与行业发展动态。

长飞公司制造中心副总经理兼光纤首席科学家马泰应邀参加此次会议。会上，长飞公司全面展示了FTTH网络系列解决方案、气吹微管微缆及其综合解决方案、透明光缆及室内布线综合解决方案等领先技术和产品，受到了与会者的青睐和高度认可。

随着亚太各国信息化建设的快速发展，FTTH网络建设浪潮持续高涨；在“数字印度”的大力推动下，印度FTTH也发展迅猛。作为全球领先的光纤光缆供应商，长飞公司以“智慧联接美好生活”为使命，一直致力于推动亚太地区及印度的通信网络建设，将竭力为电信运营商等行业客户提供最优质的产品和服务，共享互联时代。

YOFC Attended FTTH Council Asia-Pacific Conference

□ Mi Buming from Strategic Center

FTTH Council Asia-Pacific Conference, a great event in the communication industry in the Asia-Pacific region, was held in New Delhi, India from 25 April to 26 April. Nearly 600 representatives of governments, telecom operators, network project integrators, and manufacturers discussed status of FTTH construction and industrial development in India and the Asia-Pacific region.

Vice general manager of the Manufacturing Enter of YOFC and Optical Fibre Chief Scientist Ma Tai attended the meeting at invitation. At the meeting, YOFC comprehensively exhibited advanced technologies and products such as FTTH network series solutions, air blowing micro tube and micro fibre and comprehensive solutions, transparent optical cable and interior wiring comprehensive solutions, which gained admiration and recognition from meeting participants.

As information-based construction developed rapidly in

different countries in Asia-Pacific, FTTH network construction is booming. Driven by the policy of "Digital India", FTTH developed rapidly in India too. As the world's leading optical fibre and cable supplier, adhering to the mission of "Smart link, better life", YOFC is committed to the communication network construction in the Asia-Pacific region and India. It will strive to provide the superior products and services to telecom operators and customers in other industries, and share the benefit of the interactive age.



长飞公司闪耀

2017 中国海绵城市与综合管廊展

□ 特种产品事业部 毕伟

2017中国海绵城市与综合管廊建设技术装备展览会于5月24~26日在上海举办。长飞公司携光纤传感系统精彩亮相本次展会。

综合管廊是地下城市管道综合走廊，是看不见的城市“生命线”。长飞公司推出的光纤传感系统之分布式光纤测温系统，能对管廊内的电缆运行状态进行实时监测，为有效预防事故灾害的发生提供有力保障，是管廊综合监控系统中不可或缺的一部分。除了推出分布式光纤测温系统，长飞公司还展示了光纤周界监测系统，该系统能对运动、压力和振动进行有效监测，是助力海绵城市和综合管廊技术监控手段的又一有力产品。长飞展台还模拟了综合管廊现场测温演示方案，吸引了广大商家及专业观众前来交流，现场十分活跃。

随着国家对基础设施建设投入的逐年增大，采用现代化的技术手段提高海绵城市和综合管廊建设运行维护水平是当务之

急。长飞公司也将继续攻坚克难，坚持技术创新与智能制造，为海绵城市的建设及城市“生命线”的安全、稳定保驾护航。

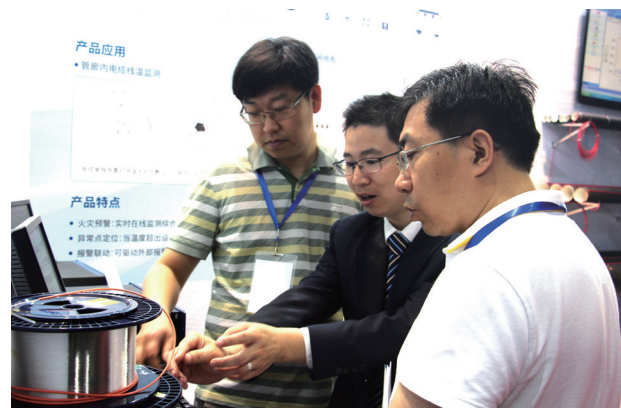

YOFC Attended China Sponge City & Comprehensive Pipe Gallery Expo 2017

□ Bi Wei from Specialty Products Business Unit

China Sponge City & Comprehensive Pipe Gallery Construction Technology Equipment Expo 2017 was held in Shanghai from 24 May to 26 May. YOFC attended the exhibition bringing with it the fiber optic sensing system.

The comprehensive pipe gallery is the pipe comprehensive corridor of the underground city and invisible "lifeline" of the city. The distributed-type optical fibre temperature measurement system of the optic sensing system launched by YOFC can real-time monitor operation status of electric cables in the pipe gallery, provide powerful guarantee to the prevention of accidents and disasters and form an integral part of the comprehensive supervision and control system of the pipe gallery. Apart from launching the distributed-type optical fibre temperature measurement system, YOFC also exhibited the optical fibre periphery monitoring system. The system can

effectively monitor movement, pressure and vibration. It is another powerful product that can enhance technology supervision and control methods for the sponge city and comprehensive pipe gallery. YOFC also demonstrated the comprehensive pipe gallery on-site temperature measurement demo scheme at its booth, which attracted mass businessmen and professional audience. The atmosphere at the site was animated.

As the state government increased investment on infrastructure construction year by year, adopting modernized technology means to improve construction, operation and maintenance of sponge cities and comprehensive pipe galleries is a high priority. YOFC will continue to overcome difficulties, adhere to technological innovation and intelligent manufacturing, and provide support to the construction of sponge cities and ensure the safety and stability of the "lifeline" of cities.

长飞公司 企业文化课堂

□ 本刊编辑部



长飞使命

智慧联接 美好生活

使命释义

新的互联时代形态——万物互联正在产生，实现“信息随心至，万物触手及”的未来智慧生活，需要坚实的技术和硬件为新一代互联网络作强有力的支撑；

长飞致力于提供全程全网、全系列光纤及解决方案，支撑光通信产业的快速发展；提供特种光纤及应用方案，在国防工业、电力电网、医疗健康、智慧城市等领域具有不可或缺性，便捷人们的生活；

长飞致力于不断的技术创新，制造更加先进、可靠的产品，提供更为优质的服务，满足社会对信息消费的需求，让人们的生活更加美好！



长飞愿景

成为信息传输与智慧联接领域的领导者

愿景释义

信息传输与智慧联接领域是长飞一直坚守的方向，除专注于光纤光缆主业外，长飞不断拓展，进行相关多元化，为信息传输和智慧联接领域提供其它产品、服务和解决方案，推动光纤技术的广泛应用；

引领行业发展是长飞的目标，在国内应当达到领袖的位置；在国际应该积极开拓，提高影响力，塑造“长飞”品牌。

具体表现在以下三个方面：

市场方面，实现主业产品市场占有率及顾客满意度的双领先；其它相关领域提升市场份额，成为重要领导者；

技术方面，持续创新，提供更为优质、可靠的产品，保证产品的高科技含量，使其处于领导地位；

品牌方面，持续加强品牌建设工作，努力提升品牌知名度、美誉度等，实现领导者地位。



长飞价值观

客户 责任 创新 共赢

核心价值观的内在关系

客户是长飞的发展动力，责任是长飞的行动准则，创新是长飞的发展源泉，共赢是长飞的最终期待。

核心价值观释义

● 客户

客户是长飞的发展动力。在兼顾企业内部客户与外部整体市场诉求上，这里的“客户”可从以下四个维度解读：管理层与普通员工之间、支撑部门与生产经营业务之间、生产经营业务部门之间、企业与外部购买者之间。一切以客户为中心，以一颗专业的心，依托过硬的专业素质，以专业的

方式去做专业的事，并最终在为客户、社会创造价值的过程中，实现长飞商业价值和社会价值的最大化。

这就要求长飞做好以下两方面。

洞察和了解客户的需求，强化“以客户为中心”的服务意识。对于企业而言，客户是企业存在的唯一理由，长飞应时时刻刻以客户为导向，将客户放在首位，并站在客户的角度去思考问题，研发产品、提供服务，通过为客户服务产生收益，促进企业的发展。

以客户为关注的焦点，真正做到重视和履行对客户的承诺，满足甚至超越客户的期待。以客户为中心，凡事都以客户的满意度为最终衡量标准，让客户感觉到价值，进一步



为客户提供差异化的产品和服务，超越客户的期待。始终坚信客户是长飞长久发展的重要保证，更是长飞长青的重要基石。

● 责任

责任是长飞的行动准则。强烈的责任感与使命感是长飞持续、健康发展的核心品质。责任成就事业，责任铸就卓越。始终将责任放在第一位，就是要做任何事情都要牢记责任，不能迷失方向，真正树立“做有责任心的长飞人”的意识。这就要求长飞从以下两方面树立责任意识。

坚守内部责任担当：在长飞内部，责任更多地体现为对工作的严谨负责与勇于担当。这就要求全体长飞人要诚信为本、踏实做事，成为最让人信赖的长飞人；明晰职责，忠实履责，不推卸、不回避、不逃避责任；持续提升专业能力和综合素质，主动适应岗位要求，切实尽责，保证产品和服务品质；勇于担当，迎难而上，提升效率，追求卓越。

忠实履行社会责任：对于长飞而言，获取利润不是唯一目的，承担社会责任也是并不可少的职责，长飞作为国内行业领导者，应发挥自身优势，将“行业带动”作为社会责任的重点领域，提供有价值的专业产品和服务；在生产安全、环保、公共卫生及社会公益

方面做出积极努力，促进经济社会健康持续发展。

● 创新

创新是长飞的发展之魂，是长飞赢得竞争、实现超越的核心动力。全面实施创新驱动战略，努力形成一种鼓励创新、容忍失败的文化和以创新提升客户价值为荣的风尚。这就要求长飞从以下三大方向提升创新能力。

不断学习：学习是创新的基础。打造学习型企业，树立终身学习的意识，更要保持开放包容的心态，不断向同业学习，向市场学习，从错误中学习，不断思考、努力实践，为实现创新奠定良好的基础。

持续创新：创新是学习的升华。在学习的基础上，以服务于组织目的为前提，紧密贴合市场诉求，规范有序，有效开拓；保持思维活跃，敢于挑战现状，挣脱束缚，积极探索，拥抱变化，努力做到与时俱进，自我超越，获得持续的竞争优势，不断开拓市场、更好地满足市场需求。

追求卓越：创新成就卓越。通过学习和创新，激励我们不断成长，实现自我期望，不断开拓视野，丰富创新形式，通过创新解决问题，通过创新提升能力，通过创新取得更好成效。相信没

有最好，只有更好，凡事要么不做，要做就做最好，用最大的努力争取更好的结果，以达到卓越的境界。

● 共赢

共赢是长飞的最终期待。共赢就是以人为本、与利益相关者分享互助，从而实现共同发展、共同繁荣，构建良好的生态圈。这就要求长飞协作共进、互利共赢。

协作共进：以开放包容的心态，积极沟通、相互尊重、主动补位，以合作凝聚整个长飞的意志与资源，以个人之力贡献团队，靠团队赢得客户和市场，齐心协力把长飞人共同的事业做好做强，实现个人利益与集体利益的共赢。

互利共赢：长飞最终追求以互利共赢为目的的良性合作，积极与内外部利益相关方构建持久稳定的合作关系，营造和谐共赢的内外部发展环境，共创价值，共同成长。对股东，稳健经营、规范运作，提供持续回报；对员工，关爱、发展、成就员工，实现员工与企业共同发展；对客户，尊重、理解客户，持续提供超越客户期望的产品和服务；对供应商，重视商业信誉，坚持良性的供求关系；对社会，坚持环境和谐、资源有效使用的有机统一，发展惠及社会、消费者和环境，并通过系统性的社会公益活动奉献社会。



长飞经营理念

企业经营理念是指企业生产经营活动的根本指导思想和基本原则，是企业领导者的世界观、方法论在企业生产经营实践中，特别是在企业生存与发展总体构想中的运用。

管理观 诚信 学习 豁达 廉洁
人才观 公平公正 举贤任能
研发观 协作创新 务实高效

供应链观 效率优先 协同共进
生产观 智能 高效 绿色 安全
质量观 精益求精 品质卓越

营销观 锐意进取 敦厚道义
安全观 安全于心 安全于行
财务观 专业细致 持筹握算

Corporate Culture Classroom of YOFC

□ The Editorial



YOFC's Mission

Smart Link Better Life

Interpretation of the mission

The new form of the Internet era - the Internet of Everything - is emerging, realizing a smart life of the future featuring 'accessing information at will and keeping all things within reach', and it calls for the powerful support of robust technology and hardware for the new generation of the Internet;

YOFC is committed to offering whole-process, whole-network and full series optical fibres and solutions, supporting the rapid development of the optical communication industry and providing special optical fibres and applications which are indispensable for the national defense industry, electric power and electric grid, medical care and health, smart city technology and other fields, thereby facilitating the lives of the people.

YOFC is committed to pursuing continuous technical innovation so as to create more advanced and reliable products, offer better services, meet the needs of society for information consumption and give people a better life.



YOFC's vision

To be the leader in information transmission and smart links

Interpretation of the vision

The information transmission and smart link field is the direction to which YOFC adheres. In addition to its focus on its main business of optical fibre and optical cable, it has constantly expanded its business into diversified fields, providing other products, services and solutions for the information transmission and smart link field, and promoting the wide application of optical fibre technology;

To be the leader of the industry is YOFC's objective. Domestically, it shall reach the position of leadership; internationally, it shall actively explore, enhance its influence and shape the 'YOFC' brand.

It is embodied in the following three aspects:

Market: To take the lead in both market share and customer satisfaction for its main business products, increase its market share in other relevant fields and turn itself into a key leader.

Technology: To continue innovating, providing better and more reliable products, ensuring that its products have hi-tech content and securing the leading position;

Brand: To continue to strengthen its brand building, endeavour to enhance its brand awareness and reputation, and achieve the leading position.



YOFC's core values

Client Focus

Accountability

Innovation

Stakeholder Benefits

Logical relations of core values

Customer Focus is YOFC's driving force of development, Accountability is YOFC's code of conduct, Innovation is YOFC's source of development, Stakeholder Benefits is YOFC's ultimate expectation.

Interpretation of core values

● Customer Focus

Customer focus is YOFC's driving force of development to give consideration to both internal customers and external overall market appeal. The 'customer' here can be interpreted from the following four perspectives: between management and ordinary employees, between supporting departments and production and operation business departments, between production and operation business departments, and between the enterprise and external purchasers. With our focus on the customers, we rely on superior professional competence and a professional approach to conduct professional business so as to ultimately achieve the maximization of YOFC's business value and social value in the course of creating value for our customers and society. This core value calls for YOFC to:

Perceive and understand the customers' needs and enhance the service awareness of 'customer focus'. The customers are the only reason for an enterprise's existence. YOFC shall be customer-oriented, give top priority to its customers, consider problems, develop

products and provide services from the perspective of customers, and yield revenue through serving its customers in a bid to promote the development of the enterprise.

Focus on the customers, genuinely value and perform our commitments to customers, and meet and even transcend customer expectations. With a focus on the customers, base everything on customer satisfaction as the final measuring criterion, make customers feel the value, provide further differentiated products and services for customers, and transcend customer expectations. Firmly believing in the customers is an important guarantee of YOFC's lasting development, and a major cornerstone for YOFC's continued flourishing.

● Accountability

Accountability is YOFC's code of conduct. A strong sense of accountability and mission is YOFC's core quality for sustainable and healthy development. Accountability is able to drive great careers and achieve excellence. To put people in first place is to keep responsibility firmly in mind, avoid losing the way and genuinely foster a sense of 'To be YOFC people with a sense of accountability'. This core value calls for YOFC to:

Persist in internal accountability. Inside YOFC, accountability is mainly embodied in rigorous accountability and brave accountability. As such, all YOFC people should be integrity-based, practical and trustworthy; perform

their duties according to their clearly-defined roles without shirking, evading or escaping from responsibilities; continuously improve their professional competence and overall quality, adapt to the requirements of their positions with initiative, fulfill their responsibilities earnestly and ensure the quality of products and services; be bold in assuming responsibilities, stride forward against hardships, improve efficiency and pursue excellence.

Fulfill social accountability faithfully. For YOFC, profit-making is not the only purpose, and assuming social accountability is also an indispensable accountability. As a domestic industrial leader, YOFC shall bring its own advantages into play, take 'sector-driven' as a key field of social accountability, provide valuable professional products and services, make positive efforts in production safety, environmental protection, public health, social welfare, etc., and promote the healthy and sustainable development of the economy and society.

● Innovation

Innovation is the soul of development and a core power for YOFC to rise above the competition and realize transcendence. We implement innovation-driven strategy in an all-around way, and endeavor to form a culture that encourages innovation and tolerates failure, and a style of improving customer value through innovation. This core value calls for YOFC to:

Continue learning. Learning is the foundation of innovation. To build a learning-type enterprise, we should establish an awareness of lifelong learning, keep an open and inclusive mindset, continue to learn from our counterparts in the market, draw lessons from mistakes, continually consider, put efforts into practice and lay a good foundation for achieving innovation.

Continuously innovate. Innovation is the distillation of learning. On the basis of learning, follow the premise of serving the purposes of the enterprise, closely adapt to market appeal, expand the market in an orderly and effective way; maintain active thinking, dare to challenge the status quo, break free from shackles, actively explore, embrace change, endeavor to keep pace with the times, achieve self-transcendence, obtain sustained competitive advantages, continue making efforts to exploit the market and better meet market demands.

Pursue excellence. Innovation will achieve excellence. Learning and innovation will inspire us to grow continuously, achieve our expectations, broaden our horizons and enrich our

innovation ability. Through innovation, we can solve problems, elevate our capacity and achieve better results. We believe that 'there is no best, only better'. Whenever we do something, we try our best to do it fully and make the utmost effort to achieve the best result and reach the realm of excellence.

● **Stakeholder Benefits**

Stakeholder Benefits is YOFC's ultimate expectation. To pursue stakeholder benefits is to be human-oriented, and share with and give mutual aid to stakeholders, thereby realizing common development and prosperity, and building a sound environment. This core value calls for YOFC to:

Collaborate and co-evolve. We strive to keep an open and inclusive mindset, actively communicate, respect each other, cover all positions with initiative, pool YOFC's overall will and resources through cooperation, contribute individual power to the team, win customers and markets by virtue of the team, make concerted efforts to enhance the common cause of YOFC people and achieve stakeholder benefits between individual interests and collective interests.

Pursue mutual benefits and stakeholder benefits. YOFC's ultimate pursuit is to engage in sound cooperation for the purpose of attaining mutual benefits and win-win stakeholder benefits. We establish lasting and stable partnerships with internal and external interested parties, create a harmonious and win-win internal and external development environment, and make joint efforts to create value and grow together. For shareholders, we carry out prudent and standardized operations, and provide continuous returns; for employees, we care for, develop and cultivate them, and realize the common development of employees and enterprise; for customers, we respect and understand them, and continue to provide products and services that exceed their expectations; for suppliers, we value business reputation and uphold a sound supply-demand relation; and for society, we adhere to the organic unity of a harmonious environment and the effective utilization of resources, benefit the development of society, consumers and the environment, and contribute to society through systematic public welfare activities.



YOFC's business philosophy

Our 'business philosophy' refers to the fundamental guiding ideology and basic principles behind the production and operation activities of the enterprise. It is an application of the enterprise leader's world view and methodology in the enterprise's production and operation practices, especially the overall conception of the enterprise's existence and development.

- Management view* Integrity Learning Generosity Incorruption
- Talent view* Justice and equity Promotion of the worthy
- R&D view* Collaborative innovation Practicality and efficiency
- Supply chain view* Efficiency as a priority Forging ahead collaboratively
- Production view* Intelligence Efficiency Green Safety
- Quality view* Continual improvement The pursuit of excellent quality
- Marketing view* Forging ahead with determination Upholding honesty and morality
- Safety view* Keeping safety in mind Reflecting it in action
- Finance view* Professionalism and meticulousness careful accounting and budgeting



VAD项目小记

□ 长飞潜江公司 渠驰

2012年我从美国归国后即加入长飞公司，有幸作为工艺技术人员参与了长飞公司VAD项目从无到有、从有到优的全过程。现在回想起来，许多场景仍历历在目。

预制棒生产一直以来都是光纤光缆行业中最重要的一环，也是附加值和技术难度最大的一环。作为一家中外合资企业，长飞公司最初从外方获得了制备预制棒的等离子化学气象

沉积法（PCVD技术）。在使用技术的同时，长飞公司通过不断研究与创新，已完全掌握PCVD技术，并且技术水平早已超越技术引进时状态，PCVD预制棒制备技术是全球三大主流技术之一，但作为一种管内法的预制棒制备技术，PCVD技术也存在自身固有的瓶颈，例如，管内法预制棒技术首先需要一根高纯石英衬管，而这种衬管目前还只能依赖进口。

固守单一工艺还是发展多元工艺？

环顾国外具有预制棒生产能力的光纤企业，光纤预制棒的制造工艺除了PCVD外，还普遍采用轴向气相沉积法（VAD技术）和外部气相沉积法（OVD技术）。三种工艺在制备不同类型的光纤预制棒时各有优缺点。与PCVD技术相比，VAD和OVD技术在



VAD技术，将多工艺路线作为公司未来发展的战略之一！研发VAD技术对于当时的长飞而言具有一定的难度和技术风险，但是凭借着公司强大的创新保障和长飞人勇于创新的精神，公司于2012年将VAD预制棒制备项目作为公司的重点项目正式立项。

第一种选择是一种风险低、成效快的办法，但是国外合作方直接从本国派遣技术人员，中方人员一般仅负责操作层面的工作，目前已经采取这种路线的国内企业至今仍然无法掌握VAD的核心技术。选择购买设备-消化吸收-再创新的路线虽然面临了更大的技术风险，但一旦成功可确保长飞能自主掌握VAD的核心技术，并且为未来进一步发展提供有利的先决条件。最终，长飞公司选择了“困难”模式，因为长飞人深知，在近30年的发展中，我们遇到了大大小小的数不清的困难，但我们从未被困难打倒！

在项目前期的调研中我们了解到，部分国外主流预制棒厂商的核心技术经过了长期的发展，技术成熟度已经非常高，这些厂商都将制棒技术作为企业最高的商业机密，即使合作也不会输出工艺技术和设备设计。另一部分厂商可以提供设备，但其技术水平成熟度却



长飞公司选择了“困难”模式，因为长飞人深知，在近30年的发展中，我们遇到了大大小小的数不清的困难，但我们从未被困难打倒！

折射率剖面控制精度与原材料利用方面都不如PCVD技术，但在制备单模光纤方面却具有生产成本较低的优势。

是继续固守PCVD一种技术，还是勇于承担风险，投入巨资开发多种预制棒制备技术？在技术团队充分调研和比较了各种预制棒制备技术后，公司领导给出了答案：固守已有技术可能会暂时安稳，但在未来的市场竞争中会处于不利地位，长飞要攻克

选择自主掌握 VAD 核心技术

项目虽然立项了，但具体的技术来源仍存在争议。一种选择是像国内其他厂商那样，与目前国外主流光纤厂商合作，直接引进对方成熟先进的全套生产线，并建立工厂运行；另一种选择是以研发的形式先购买设备，通过对设备及工艺的研究、理解、改进、升级，完成对VAD核心技术的掌握和本地化。

与主流厂商存在“代”的差距！所以当时我们面临的难题是：先进的技术无法获得，能够获得的设备又不够先进。既然选择了“困难”模式，我们就没有理由退缩，开始寻找合作的厂商。技术的改造与升级过程本身也是一个认识、了解工艺技术和培养、训练人才的过程，公司的领导层对这一过程非常看重，因为它不仅定义了我们的现在，更将定义长飞公司的未来。

奔赴瑞士，不放过每一个细节

2012年8月，由公司技术总监罗杰博士带领一队技术人员奔赴瑞士，进行设备交付前的检验与培训，同行的人员除我以外，还有技术专家张宏胜同志以及三位设备技术人员。正如大多数工业设备，使用前培训的质量会直接影响到未来设备的调试进度，若操作不当甚至可能发生安全事故。为了在为期两周的培训中能够尽可能的掌握设备特性，我们抓住一切机会了解设备。由于工艺本身的特性，一次沉积的时间短则数小时，长则近二十小时，为了能够完整地了解设备及工艺运行的特点，我们经常全程跟踪运行情况，为了一个技术细节反复与外方工程师讨论。张宏胜同志非常注重细节，对于一些看似简单却又有一定难度的操作（如粉体预制棒的卸载与转移等），都会要求亲自操作。他经常讲的一句话也是影响我很深的一句话就是：“无论多小的细节，如果我们自己都不清楚，今后如何教授其他人？”为了今后能够通过培训让

操作人员顺利地操作生产设备，为了让更多工艺人员熟悉、了解工艺过程，我们必须尽力了解每一个环节，即使它看起来很琐碎细小。外方的工厂位于瑞士中部的一个小村庄外，在培训期内，我们每天过着住地-工厂两点一线的生活。去瑞士旅游过的人多半会对瑞士的自然风光和人文地理赞不绝口，而我们在瑞士停留的时间虽然比大多数旅游的人都要长，但现在留在我脑海中的，只有为了了解设备工艺所付出的努力，以及连接住地与工厂间那一条静谧的林荫小道。

改良 VAD 设备和 技术，实现本地化

2013年1月，设备引进的工作顺利完成，设备的各项生产指标满足甚至高于我们预期，此刻虽值得庆贺，但我们知道，真正的挑战——VAD核心技术的本地化还没有真正到来。会使用设备与能制造设备之间存在着巨大的鸿沟，就比如许多人都有驾驶执照、能够熟练地驾驶汽车，但要懂得汽车的原理和设计

却并非一日之功，要造出合格的汽车更是需要非凡的能力。

设备的自制不但要求我们对工艺的原理过程必须有很深入的理解，更对系统的设计、材料的选择以及加工能力提出了很高的要求。在系统设计方面，仅借鉴外方的设计是远远不够的，因为外方的设计离世界一流水平还有不小的差距。通过一次又一次的论证，我们的工程师在已有基础上对整个工艺流程和设备设计做了重大改进。如同任何一件新产品在真正使用结果出来前，谁都没有百分之百的信心，“摸着石头过河”也是我们的必经之路。长飞自制设备总体设计由顾立新经理和张华明工程师负责，为了给之后的工艺调试留出足够的时间，也为了让设计更加完善，让长飞早一天拥有属于自己的VAD设备和技术，顾经理和张华明工程师带领其他工程师每天工作十三个小时以上已经成为家常便饭。通过不断的讨论和修改，2013年6月，设备的详细设计终于完成。这一设计完全体现了长飞工程技术人员对VAD技术的理解，在许多方面比外方设计更加完善合理。2013年12月，长飞自制设备完成工艺验收，其各项指标均达优秀，其中多项重点指标大幅超过国外引进的设备。

经过两年的连续运行考验，我们的设计被证明是合理、可靠的，具有规模扩产的价值。至此，我们可以骄傲地说，长飞公司真正掌握了VAD技术并将其本地化，公司多工艺路线的战略也迈出了坚实的一步。

如今，以长飞公司自主研发的VAD技术为基础，一座全新的现代化智能工厂已在湖北潜江拔地而起。通过技术的引进、消化吸收与再创新，长飞公司已成为全球唯一掌握PCVD、VAD、OVD三种预制棒工艺的企业。现如今，我们80后开始成为国家建设的生力军，出生于1988年的长飞也是名副其实的“80后”，充满奋斗的勇气与创造的能力，在创新精神的引领下，长飞将继续飞向巅峰。

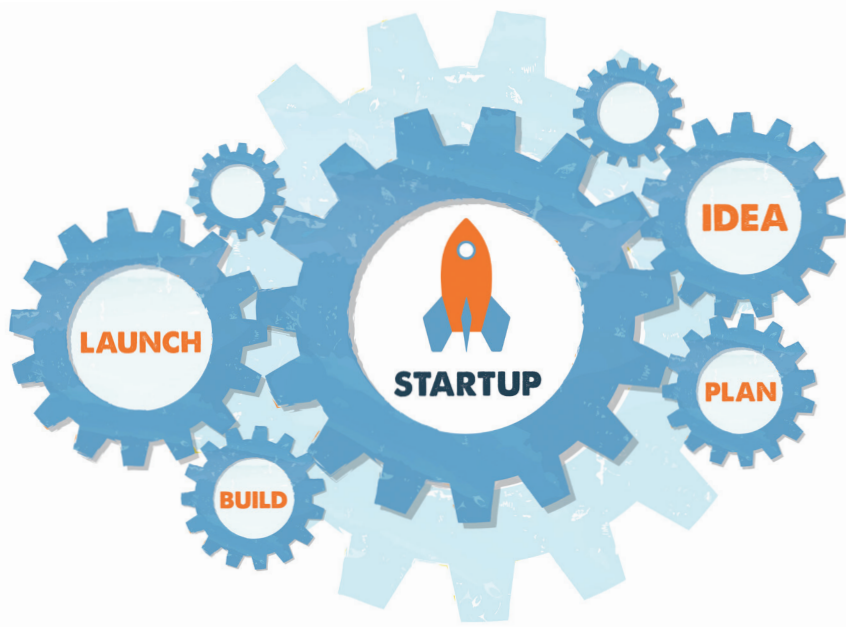



A Recount of VAD Project

□ Qu Chi from YOFC(Qianjiang)

I joined YOFC in 2012 when I just came back from America. I am fortunate enough to witness the whole process of YOFC VAD project from nothing to excellence as a technician. Even now, this remains fresh in my memory.

Preform production has always been the most important part in the fibre and cable industry and a part with most additional value and biggest technical difficulty. As a Sino-foreign joint venture, YOFC introduced the technology of Plasma Chemical Vapor Deposition (PCVD) to produce preforms from the foreign

side at the very beginning. While using the technology, YOFC has fully mastered PCVD with a much higher technical level than when it was introduced through continuous research and innovation. PCVD preform manufacturing technology is one of the three mainstream technologies around the world. However, as a kind of preform manufacturing technology used inside the tube, PCVD also has inherent bottleneck. For example, preform technology first needs a highly pure quartz liner tube, which can only be imported currently.

Single Technique or Diversified Techniques?

For all the foreign fibre enterprises capable of producing preforms, in addition to PCVD, Vapor Axial Deposition (VAD) and Outside Vapor Deposition (OVD) are universally used to produce fibre preforms. Three techniques have both advantages and disadvantages for producing different fibre preforms. Compared with PCVD, VAD and OVD are inferior in terms of accuracy of controlling refractive-index profile and raw material utilization, but they have less cost of production in

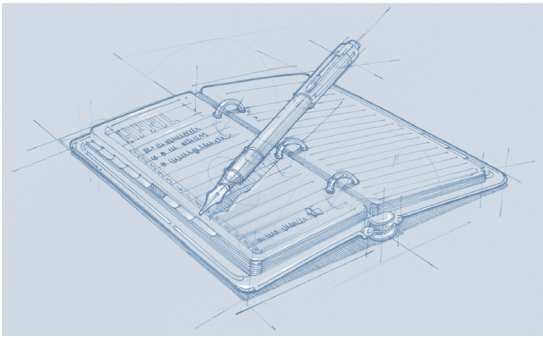

manufacturing single-mode fibre.

Should we continue to adhere to PCVD only or be brave enough to shoulder the risks to invest and develop a variety of preform manufacturing technologies? After the technical team fully investigates and compares different preform manufacturing technologies, the company leader gave the answer: insisting on the existing technology provides temporary stability, but it may make YOFC disadvantageous in the future market competition. YOFC needs to break down the technical barrier of VAD and put the route of diversified techniques one of the strategies in the future development! The R&D of VAD was tough and risky for YOFC at that time, but with the powerful innovation guarantee of YOFC and its employees' boldness to innovate, YOFC officially approved VAD preform manufacturing project as the key project in 2012.

Choosing to Be the Master of VAD Core Technology

Although the project is approved, the concrete technical source remains controversial. One choice is to work with foreign mainstream fibre manufacturers, directly introduce the mature and advanced full set of production lines and set up factories like other Chinese manufacturers; the other is to firstly purchase equipment by means of R&D and command and localize VAD core technology through the

research, understanding, improvement and upgrade of equipment and technique. Although the first one is a way with lower risk and higher efficiency, foreign partners directly send their own technicians, making Chinese employees

only responsible for operation and VAD core technology inaccessible to domestic enterprises. Although choosing the way of equipment procurement, digestion and absorption and re-innovation is faced with more technical risks, it ensures that YOFC can independently master VAD core technology once successful, beneficial to the future development. At last, YOFC chose the second one with more difficulty because all of us know clearly that we have never been defeated by different difficulties during the development in nearly 30 years!

At the initial investigation of the project, it came to our knowledge that through long-term development, the core technology of some foreign mainstream preform manufacturers is highly mature. These manufacturers all consider preform manufacturing technology as the top trade secret and will not output technology and equipment design even in cooperation. Other manufacturers can offer equipment but there is a wide gap between their technical maturity and that of mainstream manufacturers! Therefore, what we faced at that time was: inaccessible advanced technology and accessible less advanced equipment. Now that we have selected the "difficult" mode, we have no other choices but to seek cooperative manufacturers. The technical improvement and upgrade itself is a process of knowing and understanding technique and training

and cultivating talents, which is emphasized by company leaders because it defines both the current and future YOFC.

Going to Switzerland and Never Letting Every Detail Go

In August 2012, Dr. Luo Jie, YOFC Technical Director, led a group of technicians to go to Switzerland to receive the test and training before the equipment delivery. In addition to me, there were Zhang Hongsheng, a technical expert and three equipment technicians. For most of industrial equipment, the training quality before using will have a direct effect on the future tuning. Improper operation is even likely to lead to safety incidents. In order to know equipment features as much as possible in the two-week training, we have seized every opportunity to understand equipment. Due to the inherent feature of the technique, one deposition can be as short as several hours or as long as nearly 20 hours. In order to fully understand features of equipment and technique operation, we often tracked the whole process of operation and discussed with foreign engineers repetitively for a single technical detail. As a very detail-oriented man, Zhang Hongsheng would ask for operating all the seemingly easy but difficult work in person (e.g. powder preform unloading and transfer). What he always says and impresses me is, "No matter how small the details are, if we don't understand them, how can we teach others in the future?" In order to make operators operate production equipment successfully and make more technicians know and understand the technical process through training, we should try our best to understand all the details even if they look very tiny. The foreign factory is located outside a small village in the middle of Switzerland. During our training,

we led a work/home life every day. Most of the travelers to Switzerland will highly praise its natural scenery and geographical culture. Although we spent more time in Switzerland than most of them, what are in my mind now are only the effort of understanding equipment and technique and the tranquil alameda linking our residence with the factory.

Improving VAD Equipment and Technology to Achieve Localization

In January 2013, the work of introducing equipment was successfully done. All the production indexes satisfied and even exceeded our expectation, which was worth celebrating. However, we know that the real challenge – the localization of VAD core technology has not come yet. There is a wide gap between using equipment and producing it. For instance, many people have the driving license and can drive a car skillfully. However, it takes years to understand the theory and design of cars. What's more, making a qualified car needs extraordinary capabilities.

Self-made equipment requires not only an in-depth understanding of theories of technique but also system design, material selection and processing. In terms of system design,

only borrowing from the foreign design is not enough because there is a wide gap between it and first-class level in the world. Through repetitive argument, our engineers have made great improvement in the whole technical process and equipment design on the existing basis. Just as no one has the 100 percent of confidence before the real application result of a new product comes out, "wading across the stream by feeling the way" is our must. Manager Gu Lixin and Engineer Zhang Huaming are in charge of the overall design of YOFC self-made equipment. In order to spare more time for the future technical tuning, make the design better and make YOFC have its own VAD equipment and technology as early as possible, Manager Gu and Engineer Zhang Huaming led other engineers to work over 13 hours every day, which was the routine. Through continuous discussion and revision, in June 2013, the detailed equipment design was completed finally. Better and more reasonable than foreign design in many ways, the design has fully reflected YOFC engineering technicians' understanding of VAD technology. In December 2013, YOFC completed the technical inspection and acceptance of its self-made

equipment, whose indexes were all excellent, and many key indexes largely exceeded those of equipment imported from abroad.

After two years of continuous operation and test, our design is proved to be reasonable and reliable with values of enlarging production scale. So far, we are proud to say YOFC has genuinely mastered VAD technology and localized it and a solid step has been taken in the route of diversified technologies of YOFC.

Currently, based on VAD technology independently researched and developed by YOFC, a brand-new modern intelligent factory has sprung up in Qianjiang, Hubei. Through technical introduction, digestion and absorption and the second innovation, YOFC has become the only enterprise commanding PCVD, VAD and OVD preform techniques in the world. Currently, we, the generation after 1980s, begin to be the new force in national construction. Similarly, YOFC, founded in 1988, is a real "generation after 1980s" with courage to fight and ability to create. Guided by the spirit of innovation, YOFC will continue to fly to the top.

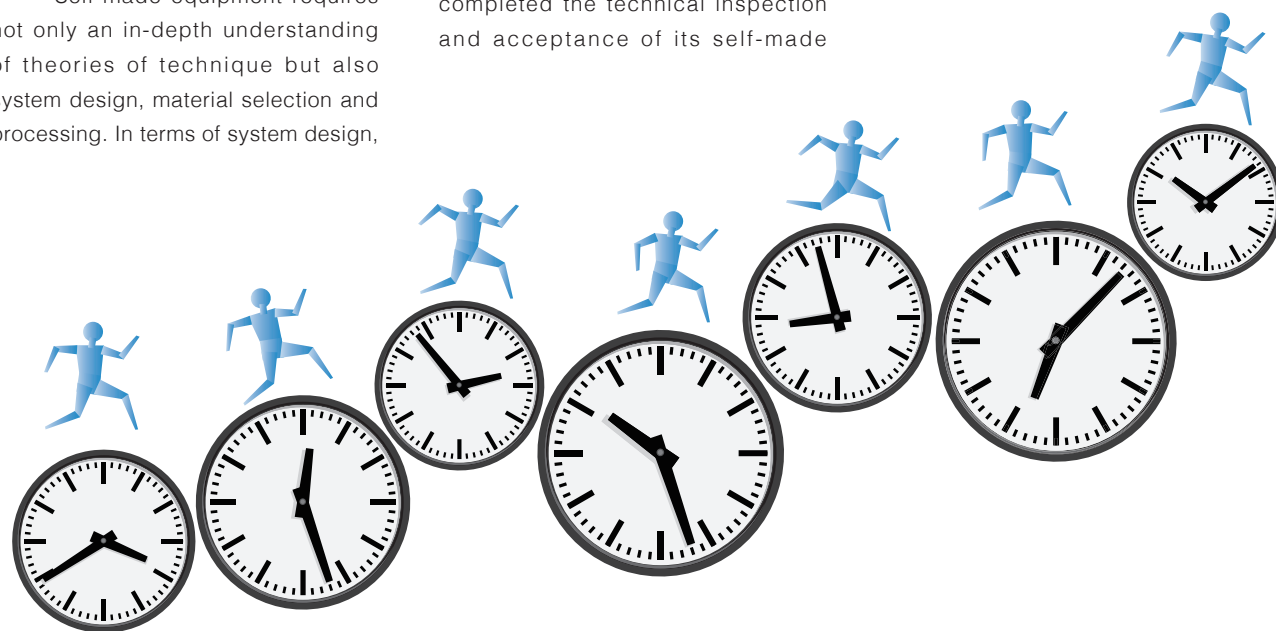



安全是企业与员工生存和发展的基础，长飞公司一贯重视安全生产，在企业文化中明确提出了“安全于心，安全于行”的安全观，始终坚持不以安全换进度，不以安全换效益，保证安全生产贯穿于企业的一切领域和过程，在任何情况下都将安全置于优先地位。

为进一步提升长飞公司科技园安全管理水平，增强全体员工安全意识，消除安全隐患，自2016年起长飞公司便在科技园开展“安全生产月”活动，将每年4月份定为“安全生产月”并组织开展系列安全生产活动。

长飞科技园于2017年4月开展了第二届“安全生产月”活动，本次活动以“传播安全文化，普及安全知识，全员参与，共同提升”为目标，活动主题是“强化安全生产保障，提升全员安全素质”。在公司安环

部的指导帮助下，科技园光缆部在安全生产月期间组织策划了一系列活动，包括刊出图文并茂的安全宣传报，悬挂以安全为主题的横幅和宣传漫画，更新安全警示标识；开展全员应急演练，检验科技园全体员工（包括科技园内的第三方公司）的安全应急能力；各班组开展工艺和设备维护保养、岗位应急处置、法律法规、全员消防演练等安全培训；开展以“安全在我身边”为主题的征文、演讲比赛；组织一线员工参加拓展活动，

并在拓展活动期间安排安全知识竞赛。

丰富多样的活动让安全的观念深入人心，也在长飞科技园营造了良好的共同关注安全的氛围。安全管理工作是一项系统工程，只有起点，没有终点。作为全球单体产能最大的光缆生产基地，长飞科技园安全管理工作任重道远。针对安全生产月活动中暴露的问题，我们将积极总结和改正，时刻做到“安全于心，安全于行”，真正在日常工作中践行公司文化，为公司的持续稳健发展保驾护航。





Safety in Mind, Safety in Behavior

□ Wang Congshun from Manufacturing Center

As safety is the foundation of the survival and development of enterprises and employees, YOFC consistently focuses on safety production and puts forward the safety concept of “safety in mind, safety in behavior” in its corporate culture, specifically, never seeking progression and benefit at the cost of safety, ensuring safety production in all fields and processes of the enterprise and putting safety production in the first place under any circumstances.

In order to further improve the level of safety management in YOFC High-tech Industrial Park, foster the safety awareness of all the employees and eliminate the safety hazards, since 2016, YOFC has carried out the event of “Month of Safety Production” in the high-tech industrial park. In every April, “Month of Safety Production” consists of a number of safety production activities.

The second “Month of Safety Production” was held in YOFC High-tech Industrial Park in April 2017. With the objective of “disseminating safety culture, popularizing safety knowledge, full participation and common development”, the event was themed by “strengthening the guarantee of safety production and improving the safety qualities of all employees”. Under the guidance and

help of the Department of Security and Environmental Protection in the company, the Cable Department in the high-tech industrial park has organized and planned a series of events during the “Month of Safety”, including publishing the illustrated safety publicity newspaper, hanging banners and publicity cartoons themed by safety, updating safety warnings; carrying out the emergency drill among all employees, testing the ability of all employees in the high-tech industrial park (including third-party companies in the park) to deal with safety emergency; carrying out safety training including process and equipment maintenance, post emergency treatment, laws and regulations and fire drill among all teams and groups; carrying out the essay and speech contests themed by “Safety is around me”; organizing

workers at the production line to attend the safety knowledge contest while taking part in additional activities.

A wide variety of activities have made the concept of safety deeply rooted among the people and created good atmosphere in YOFC High-tech Industrial Park to focus on safety. Safety management is an everlasting systematic work. As a cable production base with the largest unit capacity in the world, there is still a long way to go for the safety management work in YOFC High-tech Industrial Park. In response to the exposed issues during the “Month of Safety”, we should actively summarize and resolve them, follow the concept of “safety in mind, safety in behavior” constantly and implement the genuine corporate culture in daily work to guard for the sustainable and stable development of the company.



多芯少模光纤 在传感领域的应用

□ 特种产品事业部 刘彤庆 李博睿 童维军

基于多芯光纤和少模光纤的空分复用技术，一方面可以显著提升光纤通信系统的传输容量；另一方面，由于多芯光纤中不同纤芯、少模光纤中不同空间模式在同一光纤中共同传输时拥有不同的空间分布，这些空分光场特性会对周围环境参数的变化产生不同的响应，在此基础上可利用多芯光纤和少模光纤开展更前沿的传感技术研究。

作为全球光纤光缆行业的领导者，长飞公司一直致力于高性能特种光纤在多个领域的应用。近年来，长飞公司已联合华中科技大学光通信与光网络工程研究团队，联合研究空分复用技术的同时，也开展了基于多芯光纤和少模光纤的系列传感技术研究，并通过对多芯/少模光纤的物理、结构特性的探索，实现了多种新型高性能光纤传感器。

基于多芯光纤传感技术研究进展

凭借联合研发团队研制的高质量多芯光纤（注：光纤在1550nm衰减0.20dB/km左右，串扰低于-40dB/100km，见图1）以及空分复用/解复用器（注：插入损耗<1.5dB，串扰<-45dB，回波反射<-50dB，见

图2），多种高性能的光纤传感器已经得到实现。

1) 多芯光纤矢量弯曲传感器

如图3所示，在异质型多芯光纤同位置的不同芯上刻制布拉格光栅，由于中间芯与外围芯折射率差异，它们的布拉格系数也不相同。为了同时测量这两种不同的布拉格光栅的反射结果，我们



图1 七芯光纤截面图



图2 七芯光纤耦合器

利用一段多模光纤将多芯光纤中纤芯和一个外围芯与普通单模光纤相连接。

测试结果表明，外围芯布拉格光栅的曲率系数是光纤弯曲方向角的正弦。并且由于中间芯与外围芯的系数不同，可以用中间芯来补偿环境的温度变化，最终不仅实现了曲率的测量，也实现了光纤弯曲方向的测量，如图4所示。

2) 多芯光纤高温传感器

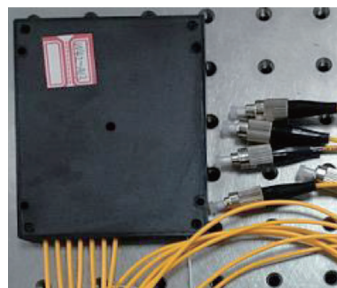
如图5所示，通过对多芯光纤和单模光纤进行拉锥，并在多芯光纤末端进行电弧放电形成一个反射面，实现线内的迈克尔逊干涉结构。从单模光纤进入的光信号先在拉锥区域耦合进多芯光纤中的外围芯，然后通过末端反射，重新在拉锥区域形成干涉。

由于多芯光纤中的空分复用和多径干涉结构，大大增强了该迈克尔逊干涉仪的温度响应系数，最终实现了165 pm/°C的灵敏度，远高于普通的迈克尔逊干涉仪。同时实现了900°C以上的高温测量，如图6所示。

3) 多芯光纤多参量传感器

如图7(a)所示，通过对异质型多芯光纤进行电弧放电拉锥处理，在拉锥处增强了纤芯之间的耦合，两个拉锥点以及中间的多芯光纤构造成了一个线内的马赫泽德干涉仪结构。由于异质型多芯光纤各个纤芯材料不同，它们的折射率变化对外界环境的响应也不同，因此各个芯的干涉系数也不相同。利用我们的低损耗复用/解复用器，最终实现了中间芯温度系数47.37pm/°C、应力系数1.10pm/μ ϵ 、外围芯温度灵敏度53.20pm/°C、应力系数0.84pm/μ ϵ ，如图7(b)(c)所示。最终，实现了利用一根多芯光纤对温度和应力进行同时测量，测量误差小于5%。

4) 多芯光纤三维形变分布式测量技术

通过对异质型多芯光纤的布里渊频移的研究，研发团队发现当多芯光纤缠绕在直径15cm的光纤盘上时，外围芯的布里渊频移会发生明显的变化，如图8(a)所示，而中间芯则无变化。通过进一步研究，发现外围芯



图3 (a) 异质性七芯光纤截面图 (b) 外围芯 (c) 中间芯 (d) 传感器结构



图4 (a) 温度系数测量结果 (b) 应力系数测量结果

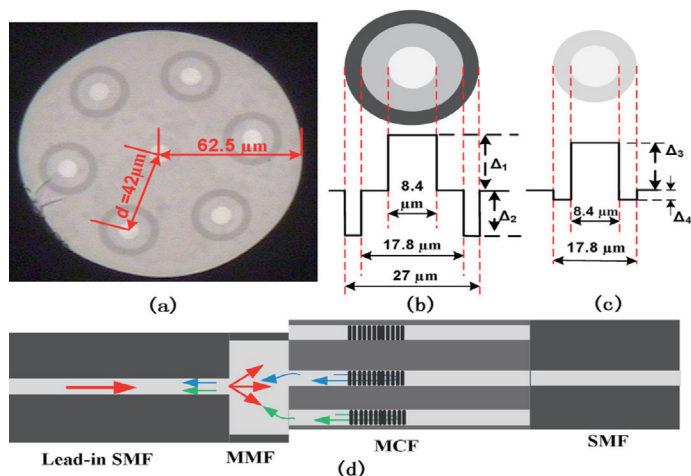

图5 (a) 多芯光纤截面 (b) 光纤结构示意图 (c) 显微镜下光纤照片 (d) 显微镜下末端反射面

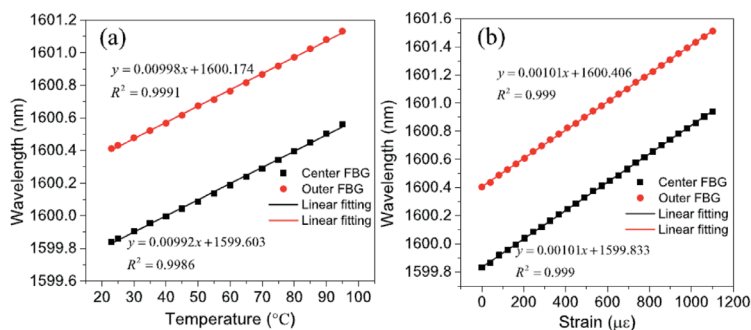

图6 (a) 温度系数测量结果 (b) 两次测量结果比较

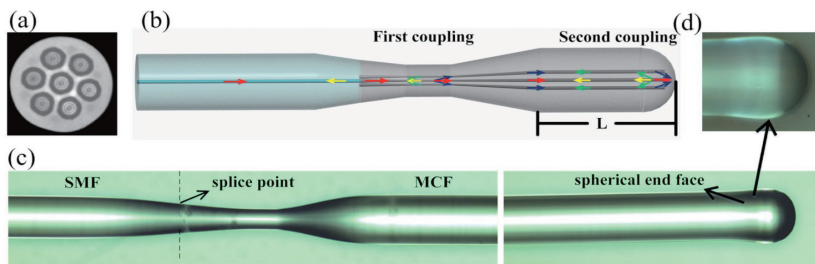

图7 (a) 多芯光纤多参数测量实验装置 (b) 应力系数测量结果 (c) 温度系数测量结果

的布里渊频移与光纤弯曲有明显的关系，并进行了定标得到了曲率系数： $2.0576 \pm 0.02132 \text{ MHz/m}^{-1}$ 。通过该技术，光纤分布式曲率和形变的测量得到了实现。

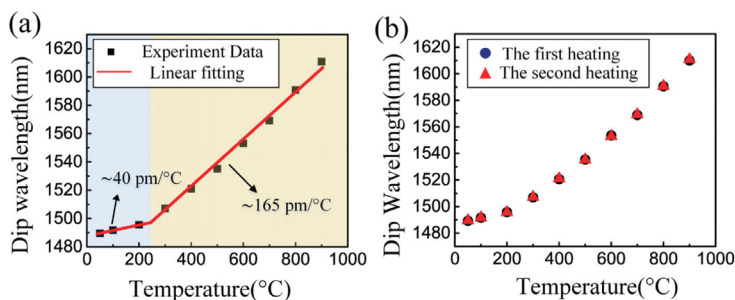
基于少模光纤的分布式弯曲传感技术研究进展

少模光纤是一种单芯光纤，与普通单模光纤相比拥有较大的模场面积，允许少量的光纤模式在光纤中共同传输。通过中心对准熔融拉锥，将少模光纤与单模器件相连接，并且保证只激励起少模光纤中的基模。通过（如图9所示）布里渊时域分析仪对少模光纤的弯曲布里渊系数进行测量，结果表明少模光纤的弯曲布里渊频移比单模光纤要灵敏得多，最终测得少模光纤的弯曲布里渊频移系数为 $11.49 \text{ MHz} \cdot \text{cm}^2$ ，如图10所示。

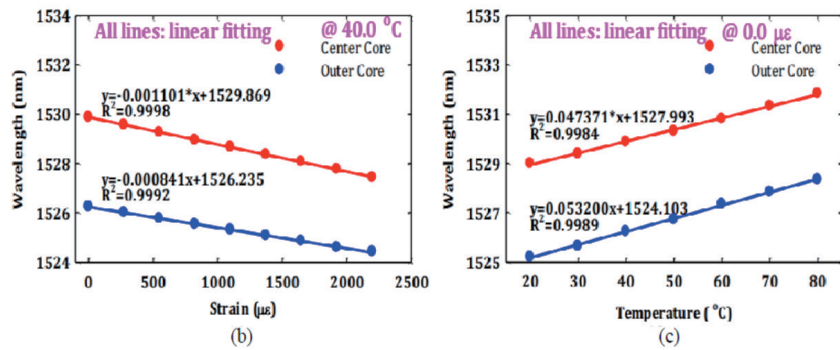
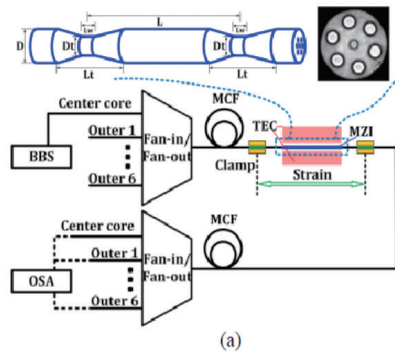
利用该成果实现了基于少模光纤的三维形貌测量。将少模光纤均匀绕至在如图11 (a) 所示的泡沫模型上，通过对该段光纤的布里渊频移测量，得到了该段光纤的弯曲半径以及不同弯曲半径情况下的光纤长度。最终恢复出了所测物体的三维形貌，如图11 (b) 所示，蓝色为真实物体，金色为测量恢复结果。

展望未来，多芯光纤和少模光纤将在弯曲、高温传感、多参量传感和三维形变分布式传感等技术应用中发挥越来越重要和独特的作用，也将不断突破单多模光纤或常规光纤传感器在传感应用中的瓶颈，拓宽特种光纤在传感应用领域的崭新维度。



图8 (a) 外围芯布里渊增益谱 (b) 外围芯弯曲半径与布里渊频移关系



图9 基于少模光纤的分布式曲率测量装置

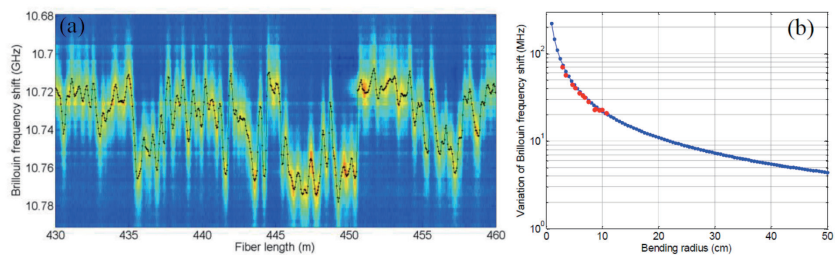

图10 单模光纤和少模光纤弯曲布里渊频移响应结果

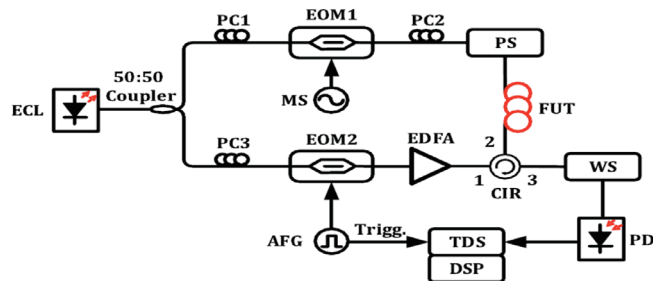

图11 (a) 待测物体 (b) 三维形貌测量结果

Application of Multi-core and Few-Mode Fibre in Sensing Field

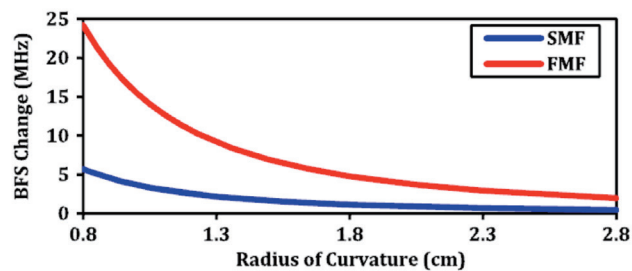
□ Liu Tongqing, Li Borui and Tong Weijun from Specialty Products Business Unit

In terms of space division multiplexing technology based on multi-core and few-mode fibre, on one hand it can significantly improve the transmission capacity of optical fibre communication system; on the other hand, because the different fibre cores of multi-core fibre and the different spatial patterns of few-mode fibre have the different spatial distributions when they are transmitted together in the same optical fibre and the characters of these space division optical fields have different responses to the changes in ambient environmental parameters, the multi-core fibre and few-mode fibre can be used for carrying out the more advanced sensor technology research.

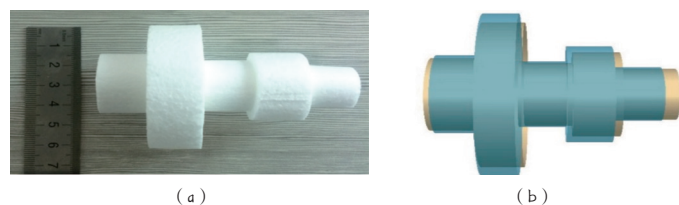
As the leader of global optical fibre and cable field, Yangtze Company has always been working on the application of high-performance special optical fibre in multiple fields. In recent years, Yangtze Company has studied the space division multiplexing technology by cooperating with photo-communication and optical-fibre network engineering research team of Huazhong University of Science and Technology. In addition, the company also carried out a series of sensor technology researches based on multi-core fibre and few-mode fibre and realized many types of high-performance optical fibre sensors.

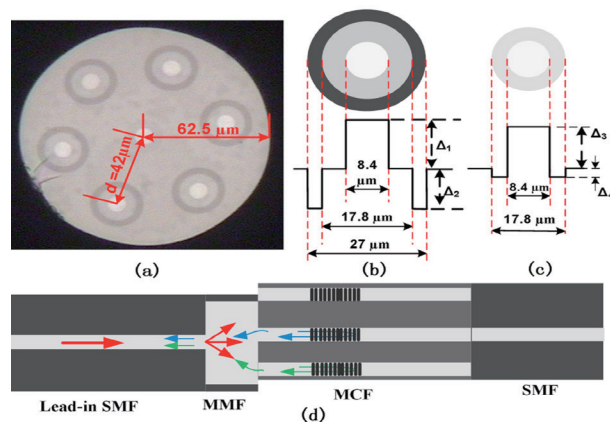

Fig. 3 (a) Section of heterogeneous seven-core fibre (b) Peripheral cores (c) central core (d) Sensor structure

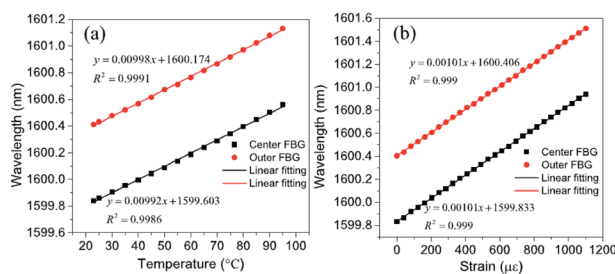

Fig. 4 (a) Measuring results of temperature coefficients (b) Measuring results of stress coefficients



Fig. 1 Section of seven-core fibre

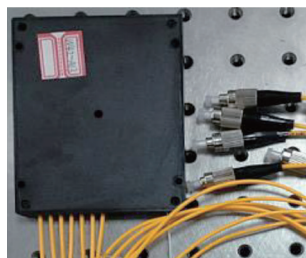

Fig. 2 Seven-core fibre coupler

Sensing technology research progress based on multi-core fibre

Relying on the high-quality multi-core fibre (note: with the length of 1,550nm, the attenuation rate of 0.20dB/km and the crosstalk below -40dB/100km, see Fig. 1) and Space division multiplexer/demultiplexer (note: insertion loss<1.5dB, crosstalk<-45dB, echo reflection<-50dB, see Fig. 2), the wide variety of high-

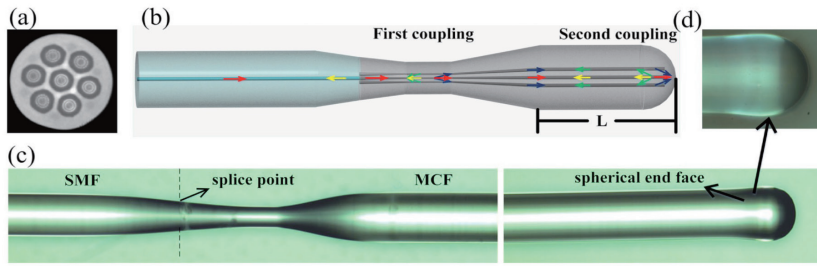

Fig. 5 (a) Section of multi-core fibre (b) Fibre structure schematic (c) Fibre picture under microscope (d) End reflecting surface under microscope

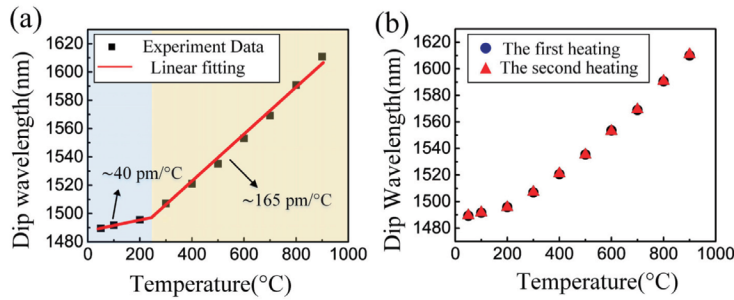

Fig. 6 (a) Measuring results of temperature coefficients (b) Comparison of measuring results at two times

performance fibre optic sensors are realized

1) Multi-core fibre vector bending sensor

As shown in Fig. 3, Bragg gratings are carved on the different cores at the same position of heterogeneous multi-core fibre. Their Bragg coefficients are also different due to the difference between the refractive indexes of central core and peripheral cores. In order to measure the reflection results of these two different Bragg gratings at the same time, we connect the central core and one peripheral core of multi-core fibre to the common single-mode fibre with

one multi-mode fibre.

From the measuring result, it can be seen that the curvature coefficient of Bragg grating of peripheral cores is the sine of fibre bending angle. Furthermore, the central core and peripheral cores are different in coefficient, so the central core can be used for compensating the temperature variation of environment. As a result, we realize not only the measurement of curvature but the measurement of fibre bending direction, as shown in Fig. 4.

2) Multi-core fibre high temperature sensor

As shown in Fig. 5, a reflecting surface can form through tapering the

multi-core fibre and single-mode fibre and the arc discharge on end of multi-core fibre, thus realizing Michelson interferometer structure within fibre. The optical signal that enters through single-mode fibre firstly couples the peripheral cores of multi-core fibre at tapering area, and then forms the interference at tapering area again by means of end reflecting.

The space division multiplexing and multipath interference structure of multi-core fibre remarkably enhance the temperature response coefficient of Michelson interferometer, so that 165 pm/°C sensitivity which is much higher than that of common Michelson interferometer is achieved. Besides, the high-temperature measurement above 900°C is realized, as shown in Fig. 6.

3) Multi-core fibre multiparameter sensor

As shown in Fig. 7 (a), after the arc discharge and tapering treatment of heterogeneous multi-core fibre, the coupling among fibre cores at the tapering area is strengthened, and two tapering points and the central multi-core fibre structure become the mach-zehnder interferometer structure within fibre. Materials of all cores of heterogeneous multi-core fibre are different and the responses of their refractive index changes to external environment are different, so the interference coefficients of all cores are also different. Using our low-loss multiplexer/demultiplexer, we finally achieve the central core temperature

coefficient 47.37pm/°C and stress coefficient 1.10pm/με, peripheral cores temperature sensitivity coefficient 53.20pm/°C and stress coefficient 0.84pm/με, as shown in Fig. 7 (b) (c). Finally, we can use one multi-core fibre to measure the

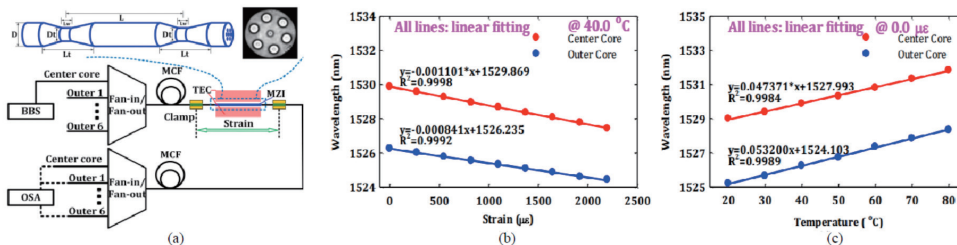

Fig. 7 (a) Multi-parameter measurement and test device of multi-core fibre (b) Stress coefficient measuring results (c) Temperature coefficient measuring results

temperature and stress at the same time, with measuring error below 5%.

4) Multi-core fibre three-dimension deformation distributed measurement technology

Based on the research on Brillouin frequency shift of heterogeneous multi-core fibre, the research team finds that when the multi-core fibre wraps around the fibre panel with diameter of 15cm, Brillouin frequency shift of peripheral cores will have the great change, as shown in Fig. 8 (a), but that of the central core has no change. Through the further research, it is found that Brillouin frequency shift of peripheral cores has the obvious relationship with fibre bending. Moreover, the curvature coefficient: $2.0576 \pm 0.02132 \text{ MHz/m}^{-1}$ is obtained after calibration. Through this technology, measurement of fibre distributed curvature and deformation is realized.

Distributed bending sensing technology research progress based on few-mode fibre

Few-mode fibre is a kind of single-core fibre. Compared to the common single-mode fibre, it has a larger mode field area and allows few fibre modes to transmit in fibre. Through center alignment, fusing and tapering, the few-mode fibre can be connected with single-mode device and only the fundamental mode of few-mode fibre is activated. The Brillouin time domain analyzer is used for measuring the bending Brillouin coefficient of few-mode fibre (as shown in Fig. 9). The results show that the few-mode fibre is much more sensitive than single-mode fibre in Brillouin frequency shift and finally the Brillouin frequency shift coefficient of few-mode fibre is measured as $11.49 \text{ MHz} \cdot \text{cm}^{-2}$, as shown in Fig. 10.

The measurement of three-dimensional shape based on few-

mode fibre is realized by means of this achievement. The few-mode fibre wraps around the foam model show in Fig. 11 (a) uniformly. Through measuring the Brillouin frequency shift of this segment of fibre and its fibre lengths under different bending radiuses are obtained. Finally the three-dimensional shape of object to be tested is recovered, as shown in Fig. 11 (b), the blue part is the actual object and the golden part is the

recovery result after measurement.

Looking forward to the future, multi-core fibre and few-mode fibre will play a more and more important and unique role in bending and high-temperature sensing, multi-parameter sensing, three-dimension deformation distributed sensing and other technology applications, break through the bottleneck of single and multi-mode fibre or common fibre sensor in sensing application, and expand the new dimension of special fibre in sensing application field.

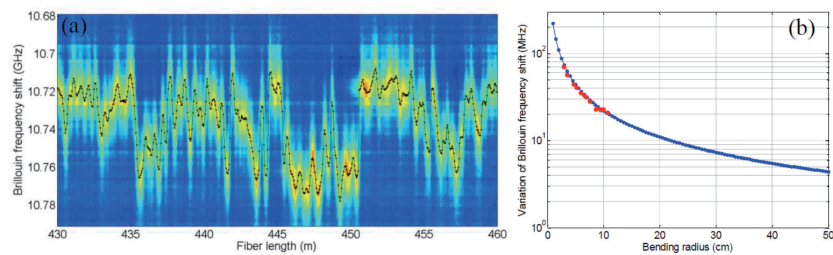

Fig. 8 (a) Brillouin gain spectrum of peripheral cores (b) Relationship between bending radius and Brillouin frequency shift of peripheral cores

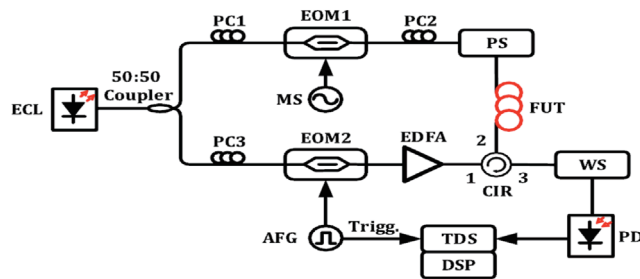

Fig. 9 Distributed curvature measurement device based on few-mode fibre

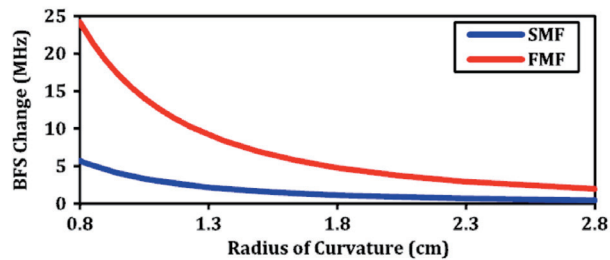

Fig. 10 Bending Brillouin frequency shift response results of single-mode fibre and few-mode fibre

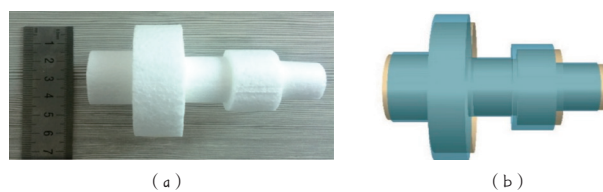

Fig. 11 (a) Object to be tested (b) Three-dimensional shape measuring results



长飞公司 举行第四届气排球比赛

□制造中心 程恒

6月11日，长飞公司第四届气排球比赛在华中科技大学光谷体育馆拉开帷幕，运动员们用精湛的球技展示了气排球的魅力，用团结一心、众志成城的精彩表现为观众呈现了一场场激烈的比赛。本届气排球比赛共有包括职能中心、研发、特产、预制棒、光纤、光缆在内的六支队伍参赛。

在预赛阶段，比赛就已进入白热化，多年稳进前三名的职能中心队居然意外被淘汰出局，而蛰伏多年的研发队异军突起，一路冲进了半决赛。在决赛中，上届比赛的冠军——光缆队、特产队又碰面了，这两个队的主力队员都是即将出征湖北省通信行业气排球比赛的长飞队成员。两强相遇，悬念无穷，赛场如同战场，双方队员

都不敢懈怠，任何疏忽都会失去宝贵的一分。随着比赛的持续，双方比分交替上升，一个个精彩扣球、一次次成功的拦网，双方队员都充分发挥了出色的个人技术，也很好地实现了战术配合。每一次精彩的扣杀、每一次成功的救球，都令在场的观众欢呼不已，加油声此起彼伏。最终，得益于更出色的团队配合，特产队成功阻击了光缆队蝉联冠军的梦想，夺得了本届气排球比赛的冠军，光缆队、研发队分获亚军和季军。

气排球比赛的成功举办，让员工们在运动中寻找到了快乐，在运动中收获了健康，也激励大家以更加饱满的激情去营造一个更强大的长飞团队——我们的长飞大家庭。



The 4th Balloon Volleyball Competition of YOFC

□ Cheng Heng from Manufacturing Center



On June 11, the 4th Balloon Volleyball Competition of YOFC was held in Optics Valley Stadium of Huazhong University of Science and Technology. Players have displayed the charm of balloon volleyball with their skills and presented audience with wonderful matches with their unity and strength. Six teams including Function Center, R&D, Specialty Products, Preform, Fibre and Optical Cable participated in the balloon volleyball competition.

The competition turned white-hot in the preliminary match. Unexpectedly, the Function Center team, in the top three for many years, was knocked out. While the R&D team, dormant for many years, suddenly rose to advance to the semi-final. In the final, the Optical Cable team and the Specialty Products team, the champion and the runner-up respectively of the last competition, met again. The lead players of both sides are both to participate in the Hubei



Provincial Communications Balloon Volleyball Competition on behalf of YOFC. When the two meet, the suspense is endless. The competition field is just like a battlefield, where athletes of both sides cannot afford to slack off because any negligence will lead to loss of a precious point. As the competition went, the two sides scored alternately. With wonderful spiking and blocking, both sides have displayed their excellent individual skills and achieved the excellent tactical coordination. Every

wonderful smash and successful save made the audience acclaim with a wall of cheers. Finally, thanks to excellent teamwork, the Specialty Products team has successfully defeated the defending champion Optical Cable team and took the crown. The Optical Cable team and the R&D team won the second and third prize respectively.

Employees have found happiness and health from sports in the successful balloon volleyball competition, which also encourages all the employees to build a stronger YOFC team with more passion our YOFC big family.



累并快乐着

——光缆部拓展训练小记

□ 制造中心 王凤

今年4月，公司光缆部组织了一次拓展活动，我是第十组的队长，也是十个组中唯一的女队长。拿到队员名单后，我第一时间联系了所有成员，成立了拓展活动群，我们很快完成了队名、队歌、口号、队徽的设计。我们的队名是“龙飞凤舞”队，队歌是《改变自己》，口号是“十组十组，风雨无阻，十组十组，龙飞凤舞”。

拓展场地没有树荫，没有商店，周边军事化的训练设施让我有点紧张，但我相信我们是最棒的！做好准备工作后，我们很快完成了破冰分组和授旗仪式，接下来就是第一项比赛活动：蛟龙出海。这是一个讲究团队合作的项目，需要大家绑脚横着前进，对脚步的协调性要求非常高。我们派出了10位身高相近、协调性较好的队员出征，他们虽然在一次次摸索摔倒，但相互鼓励。在磨合中，队员们找到了齐心协力、同步前进的技巧。在大家的努力下，我们组取得了第二名的好成绩，与第一名仅相差不到一秒钟。成绩出来后我们相互击掌以示庆祝，此刻我体会到我们小组的团结气氛正在不断升温。

在下午拓展活动中有一项难度最



大的活动：穿越电网。这个活动的难点在于我们如何将第一名和最后一名队友穿越电网送到对面，还不能触碰到电网。一开始大家跃跃欲试，在摸索的过程中屡屡触网。一次次失败，一次次总结，最后我们决定分工合作，根据网格的大小和队员的体形，进行合力安排，严密分工，有人指挥、有人帮助、有人监护，抱、抬、托、举，各种手法齐上，最终大家全部顺利钻过了电网。全体成员通过后大家不断鼓掌，这掌声是送给帮助自己的同伴，也是送给我们整个团队。在大家齐心协力的努力下，我

们组最后获得团体第二名的好成绩。

从拓展训练的准备工作到实际执行，整个过程都让我受益匪浅。这次拓展活动让我学会相信自己、信任同伴、相信集体。要想完成一项合作性的任务，团队整体的效率极其重要，而要保持整个团队的最佳状态，必须增进彼此的了解，加强相互之间的信任感。在这次拓展训练中，我所在的团队正是在紧密的合作中增进了对彼此的了解和信任。我相信在以后的具体工作中，这个团队中的成员相互协作的效率和质量都会有很大提高。

Tired but Happy

—A Recount of Outward Training in Optical Cable Department

□ Wang Feng from Manufacturing Center



This April, YOFC Optical Cable Department organized an outward-bound activity. I am the leader of the 10th team and the only female team leader among 10 teams. I contacted with all my team members upon receiving the member list and formed the group at once. The design of team name, team song, slogan and team logo was completed pretty fast. Our team name is "Flying Dragons and Dancing Phoenixes", team song is Changing Yourself and slogan is "10th Team, 10th Team, in All Weathers, 10th Team, 10th Team, like a Flying Dragon or Dancing Phoenix".

There are no tree shades or shops in the field and the surrounding military training facilities made me a little nervous. However, I had faith in our team members because we are the greatest! After making the preparation, we finished the icebreaking grouping and the flag-giving ceremony soon.

The next is our first game: "Three-Legged Race". This is a game requiring teamwork and footstep coordination because it needs everyone to bind their feet and move forward transversely. We have sent 10 group members with similar height and good coordination to participate. Although they fell in every trial and error, they encouraged each other. Through fitting together, all the team members have found the skill of pulling together and moving forward. With the efforts of all team members, our team finally won the 2nd prize, less than a second behind the first one. After the result came out, we clapped hands with each other to celebrate. At that moment, I could feel the atmosphere of unity in our team was continuously heating up.

We experienced the most difficult activity in the afternoon: Through the Grid! The difficulty of this activity lies in how to send the first and last member

to the opposite through the grid without touching it. At the beginning, all of us were eager to have a try but frequently touched the grid in trial and error. After repetitive failure and summary, finally we decided to share the work and cooperate with one another and pulled together to arrange and divide our labor strictly according to the grid size and body shape of members. With people commanding, helping and guarding and a wide variety of methods such as hugging, lifting, holding and raising, finally all of us successfully passed through the grid. After that, all of us continuously clapped our hands to pay tribute to our companions who had helped us and the whole team. With the concerted effort of everyone, finally, our team won the second prize.

From the preparation to the implementation of outward training, the whole process benefits me a lot. It makes me learn to trust myself, companions and the group. On the one hand, to finish a cooperative task, the overall team efficiency is very important. On the other hand, to keep the best status of the whole team, one must increase the mutual understanding and mutual trust. In this outward training, my team has increased the mutual understanding and trust just through close cooperation. I believe that in the future concrete work, the efficiency and quality of collaboration among members in my team will improve a lot.

激情飞扬 谁“羽”争锋

□ 长飞潜江公司 李杰蓉
制造中心 汪从顺

羽毛球是大众强身健体的运动方式，也是增进友谊、熔炼团队的有效形式。近日，长飞公司携手中国石化江汉油田分公司盐化工总厂组织了一场羽毛球友谊赛，也组队参加了武汉东湖高新区的羽毛球邀请赛，长飞人在激情飞扬的赛场上挥洒汗水、一展风采。

5月18日，一场以“以球会友，团结奋进，盐化长飞，携手共发展”为主题的羽毛球友谊赛在五七油田羽毛球馆举行，长飞潜江公司和盐化工总厂分别组队参加。该比赛分为男单、男双、混双三种形式，采用三局两胜制。第一场长飞潜江公司总经理罗杰和工程部经理方东权组队双打，双方队员均有所保留以试探对手实力，由于配合失误，长飞潜江公司输掉了第一局比赛。随后，罗总多次灵活调球落到对方防守薄弱的位置得分，方经理多次跳起杀球得分，长飞潜江公司拿下第二局比赛。在决定胜负的第三局，双方都拿出百分之百的激情与活力，



发挥全部实力，比赛也进入白热化。对方使出各种杀球技能，我方配合默契迎战，双方不甘示弱，比分非常接近，观众看得胆战心惊，最后长飞潜江公司以一分之差惜败于盐化工总厂队。

5月20~5月21日，武汉市东湖高新区在湖北奥林匹克中心举行了高新区总工会第九届职工羽毛球邀请赛，共有60余只代表队报名参加，长飞公司组队报名参加。本次比赛设男子单打、女子单打、男子双打、混合双打、第二男子双打五个单项，分小组赛和淘汰赛两个阶段。小组赛中，长飞代表队两胜

一负，以小组第二的成绩成功晋级32强。进入淘汰赛，长飞代表队干脆利落以3:0战胜对手，晋级16强；面对曾经在小组赛以3:2赢过我们的对手，长飞代表队队长杨明精心布阵并亲自出场男单，最终3:0横扫对手顺利晋级八强；在争夺前四名的比赛中，长飞队与中地数码队交锋，双方紧追比分，拼尽全力，最终长飞队惜败。

在不同的赛场上，长飞人展现了永不服输、勇于拼搏的精神面貌，队员之间的团队合作意识进一步提高，团队建设水平也得到了提升。

With Full of Passion, Who will Be the Winner

□ Li Jierong from YOFC(Qianjiang)
Wang Congshun from Manufacturing Center



As a kind of sports to make people fit, badminton is effective to increase friendship and unite teams. Recently, YOFC has organized a badminton friendly match together with Sinopec Jiangnan Salt & Chemical Complex and constituted a team to attend the badminton invitational tournament of Wuhan East Lake High-tech Development Zone. All YOFC employees sweat and fight at the fierce competition to show their vigor and enthusiasm.

On May 18, a badminton friendly match themed by "communicating with friends, forging ahead in unity and seeking common development of both Salt & Chemical Complex and YOFC" was held at the badminton stadium of Wuqi Oilfield and YOFC (Qianjiang) and Salt & Chemical Complex constituted their own team to attend. The match consists of three forms, namely, men's singles, men's doubles and mixed doubles, adopting the "best of three games" system. In the first game, Luo Jie, general manager of YOFC(Qianjiang), and Fang Dongquan, general manager of YOFC Engineering Department, constituted doubles. Players of both sides did not give the maximum in order to have an understanding of the strength of opponents. However, due to the mismatch, YOFC(Qianjiang) lost the first game. In subsequent games, General Manager Luo flexibly hit the shuttlecock to parts of the court most vulnerable to attack for many times and scored while General Manager Fang jumped upwards for smashes for many times and scored. YOFC(Qianjiang) won the second game. In the most competitive third game, both sides gave their maximum with their full enthusiasm and vitality, sparking a bitter fight. With a wide variety of smashes and good teamwork of our company, both sides were not willing to be outdone to make the score very close and audience feel thrilled. In the end, pitifully, YOFC(Qianjiang) was defeated by Salt & Chemical Complex by one point.

From May 20 to 21, Wuhan East Lake High-tech Development Zone has held the 9th Staff Badminton Invitational Tournament of High-tech Zone Federation of Trade Unions at the Hubei Olympic Center. Altogether over 60 representative teams signed up to attend and YOFC was one of them. The tournament consists of five forms, namely, men's singles, women's singles, men's doubles, mixed doubles and the second men's doubles, with group game and knockout game. In the group game, YOFC finished second with two wins and one defeat and successfully advanced to the top 32 teams. In the subsequent knockout game, the YOFC representative team defeated the opponent at 3:0 and advanced straight to the top 16 teams; in the face of the opponent defeating us at 3:2 in the group game, Yang Ming, team leader of the YOFC representative team, made a careful plan and played in person for men's singles, sweeping across the opponent at 3:0 and advancing successfully to the top 8 teams; for advancing to the semi-finals, in fight with the Zondy Cyber team, both sides tried their best to keep close and unfortunately YOFC was defeated in the end.

At different courts, YOFC employees have displayed their spirit of never giving in and fighting courageously with growing teamwork awareness among team members and level of team construction.

快乐工作 快乐生活

——长飞兰州公司与和盛堂药业公司举行系列联谊活动

□ 长飞兰州公司 时恒



长飞兰州公司是一个年轻化的群体，自公司建厂到投产运营，来自不同地区的年轻人加入公司，在这里挥洒汗水、奉献青春。为丰富广大员工的文体娱乐生活，增强团队协作精神和公司凝聚力，同时也为了给广大青年员工提供交友的平台，长飞兰州公司与兰州和盛堂药业公司于5月27日举行了一场联谊活动，活动内容包括组织篮球友谊赛和交友联谊会。

篮球赛的通知一经张贴，长飞兰州公司的各个部门便积极响应，纷纷组织员工报名参赛。经过公司内部的对选拔，长飞兰州队最终选出10名运动员与和盛堂公司进行PK。比赛前，双方运动员均做好了充分的热身准备，并互相握手致意。比赛开始后，队员们迅速投入到激烈的比赛中。尽管天气炎热，但队员们个个激情满满、斗志昂扬，现场的欢呼声、呐喊助威声让比赛气氛不断升温。比赛中双方队员紧咬比分，水平不相上下。在比分持平的情况下，长飞兰州队的队员们发挥出了顽强拼搏的体育精神，敢打敢拼、每球必争，结束哨声响起的那一刻，比分定格在32:37，长飞兰州队取得了比赛的胜利！

整个比赛过程中，场上的队员们不仅展示了专业的篮球技巧，还展现出了高尚的个人素质。本着“友谊第一，比赛第二，球场上的对手，球场下的朋友”的精神，赛后两队队员走到一起进行了友好的沟通，交流了攻防技巧和心得体会并合影留念。

篮球比赛过后，我们迎来了本次联谊的第二个活动——交友联谊会。本次交友联谊会主要是为了给公司广大男青年提供一个真诚、高效的交友平台，使青年员工们可以更好地融入长飞兰州，让每一位

员工在长飞兰州都有家的归属感。联谊活动在长飞兰州公司常青主任和和盛堂药业公司董建斌总监的致辞中拉开序幕，活动过程中青年员工们进行自我介绍、互动提问，并且开通了交友微信群，为单身青年们后续交流架起了桥梁。

今后，长飞兰州公司将继续本着“快乐工作，快乐生活”的理念，从促进员工身心健康的角度出发，举办更多、更好的文体活动，充盈公司的企业文化建设，推动长飞兰州公司蓬勃快速发展。



Happy Work, Happy Life

— The Serial Fellowship Activity of YOFC (Lanzhou) with Holyshine Pharmaceutical Company

□ Shi Heng from YOFC (Lanzhou)



YOFC (Lanzhou) is a young group. Since its establishment to operation, youngsters in different regions have joined the company to devote their youth to it. In order to enrich the recreational life of employees, enhance teamwork spirit and company cohesion and providing young employees with a platform for making friends, YOFC (Lanzhou) and Lanzhou Holyshine Pharmaceutical Company held a fellowship activity on May 27. The activity consists of friendly basketball match and dating fraternity.

Different departments of YOFC (Lanzhou) have actively responded and organized employees to attend as soon as the notice of the basketball match was announced. Through the internal confrontation and selection of the company, YOFC (Lanzhou) finally selected 10 athletes to fight with Holyshine. Before the match, athletes of both sides did fully warm-up exercises and shook hands with each other. As soon as the match began, athletes got into it quickly. Despite the hot weather,

athletes of both sides kept the score very close with similar level. When the score was flat, athletes of YOFC (Lanzhou) showed their tenacious sportsmanship, with their courage in every fight. When the final horn sounded, the score was 32:37 and YOFC (Lanzhou) won the match! During the whole match, on-site athletes have displayed not only professional basketball skill but also good personal qualities. In the spirit of "friendship first, competition second, opponents at the court, friends off the court", after the match, athletes of both sides gathered together to have a friendly communication in offensive and defensive skills, feelings and experiences and take group photos to

all the athletes maintained their passion and vigor and the on-site cheers and shouts made the atmosphere more lively. During the match,

mark the occasion.

After the match, we welcomed the second activity of the fellowship - dating fraternity. The dating fraternity aims to provide numerous young men in the company with an honest and efficient platform for making friends so that young employees can be better integrated to YOFC (Lanzhou) and each of them can feel a sense of belonging in YOFC (Lanzhou). With the speech of Chang Qing, Director of YOFC (Lanzhou) and Dong Jianbin, Director of Holyshine Pharmaceutical Company, the dating fraternity commenced. During the activity, young employees made self-introduction, raised interactive questions and opened a WeChat group, thus building a bridge of future communication for single youngsters.

In the future, with the principle of "happy work, happy life", YOFC (Lanzhou) will hold more better recreational activities in order to improve the physical and mental wellbeing of employees, enrich the corporate culture and promote the flourishing and rapid development of YOFC (Lanzhou).





手机扫描二维码

长飞光纤光缆股份有限公司

地址：武汉市光谷大道9号（430073）

电话：027-87802541

传真：027-87802534

网址：www.yofc.com