

# Specialty Optical Fibre Components and Modules





Founded in July 2004, Yangtze (Wuhan) Optical System Corp., Ltd. is a high-tech company with Yangtze Optical Fibre and Cable Joint Stock Limited Company (YOFC) as the largest shareholder. We develop, produce and sell optical fibre devices for optical fibre communications and fibre lasers, and provide relevant services. Our products mainly include fibre bragg gratings (FBG), dispersion compensation fibre modules and related optical devices. We are the first professional manufacturer of dispersion compensation fibres and modules with patented technology in China, and have the right to import and export products. For more than a decade, we have won the recognition and trust of Huawei, ZTE and other users by virtue of our mature technology and reasonable price. Meanwhile, we have been the largest supplier of dispersion compensation fibre modules in the Chinese market for eight consecutive years. Advocating a "practical, pioneering, hard-working, collaborative, and dedicated" corporate culture, implementing the "safety first policy", and through standard management, we provide users with high-tech and environmentally friendly products. This way, we enrich the lives of the general public and advance technology with our products and services.

# Specialty Optical Fibre Components and Modules

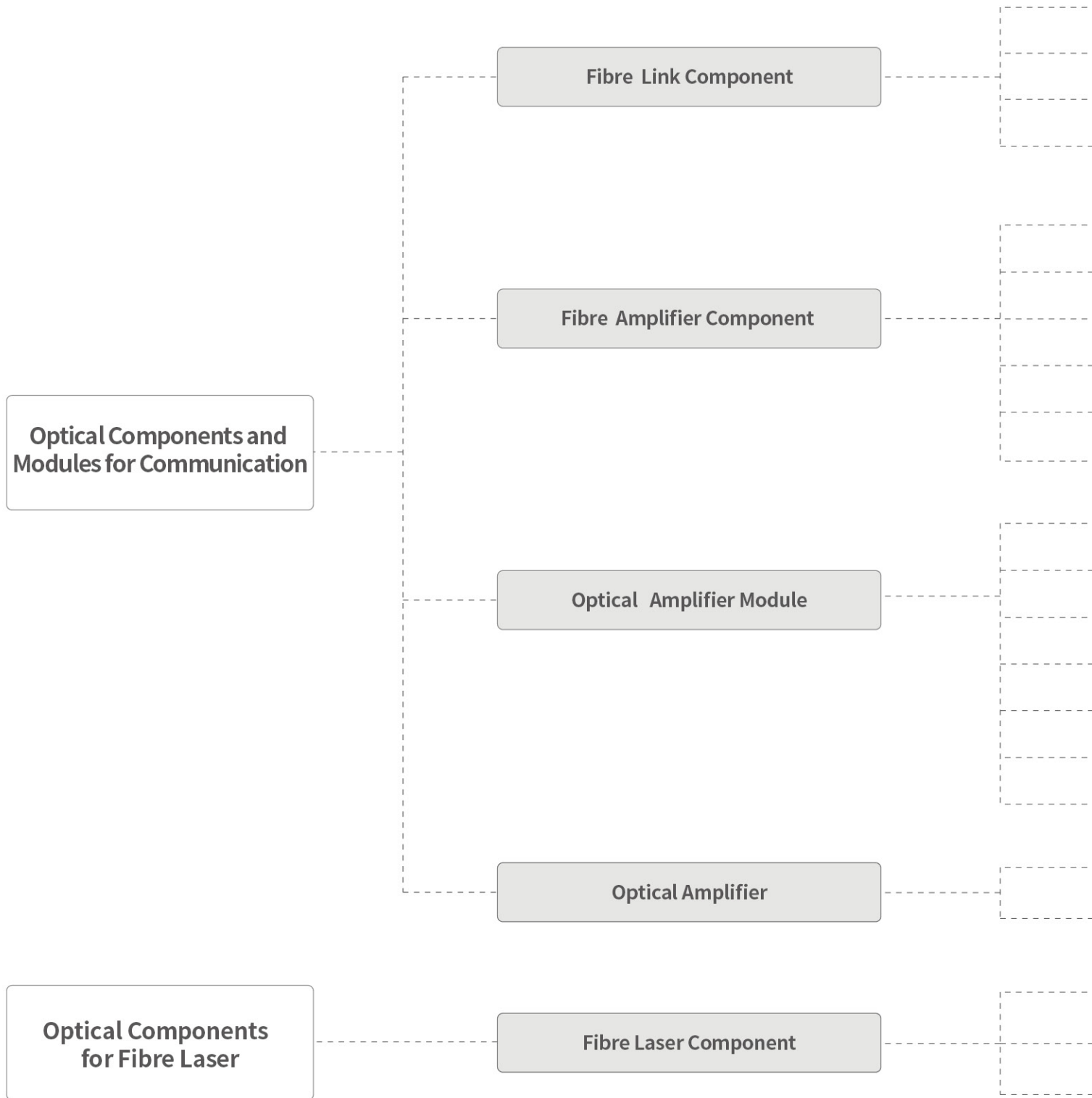

OTDR FBG Reflector

Optical Fibre Attenuator

Ultra-miniaturized Dispersion Compensation Module

Ultra-miniaturized DCM for O+E+C Band

FBG for 980nm Pump Laser

Optical Fibre Isolator

Wavelength Division Multiplexer

CWDM Mux/Demux Module

Optical Fibre Combiner

Active Fibre Combiner

MSA EDFA Gainblock

H-MSA EDFA Module

MSA Fixed Gain EDFA Module

MSA Variable Gain EDFA Module

C+L Band EDFA Module

Mini EDFA Module

High Power EYDFA Module

Benchtop Optical Amplifier

High Power EYDFA System

$(2+1) \times 1$  Optical Fibre Combiner

$(6+1) \times 1$  Multi-Mode Pump Combine

Fibre Bragg Grating for Fibre Laser

# Contents



## Optical Components and Modules for Communication 01

<b>Fibre Link Component</b> .....	02
OTDR FBG Reflector .....	02
Optical Fibre Attenuator .....	04
Ultra-miniaturized Dispersion Compensation Module .....	06
Ultra-miniaturized DCM for O+E+C Band .....	08

<b>Fibre Amplifier Component</b> .....	11
FBG for 980nm Pump Laser .....	11
Optical Fibre Isolator .....	13
Wavelength Division Multiplexer .....	14
CWDM Mux/Demux Module .....	15
Optical Fibre Combiner .....	16
Active Fibre Combiner .....	17



<b>Optical Amplifier Module</b> .....	19
MSA EDFA Gainblock .....	19
H-MSA EDFA Module .....	20
MSA Fixed Gain EDFA Module .....	21
MSA Variable Gain EDFA Module .....	22
C+L Band EDFA Module .....	23
Mini EDFA Module .....	24
High Power EYDFA Module .....	25
<b>Optical Amplifier</b> .....	27
Benchtop Optical Amplifier .....	27
High Power EYDFA System .....	28

## **Optical Components for Fibre Laser** .....

**32**

<b>Fibre Laser Component</b> .....	33
(2+1) × 1 Optical Fibre Combiner .....	33
(6+1) × 1 Multi-Mode Pump Combine .....	34
Fibre Bragg Grating for Fibre Laser .....	35

# Optical Components and Modules for Communication

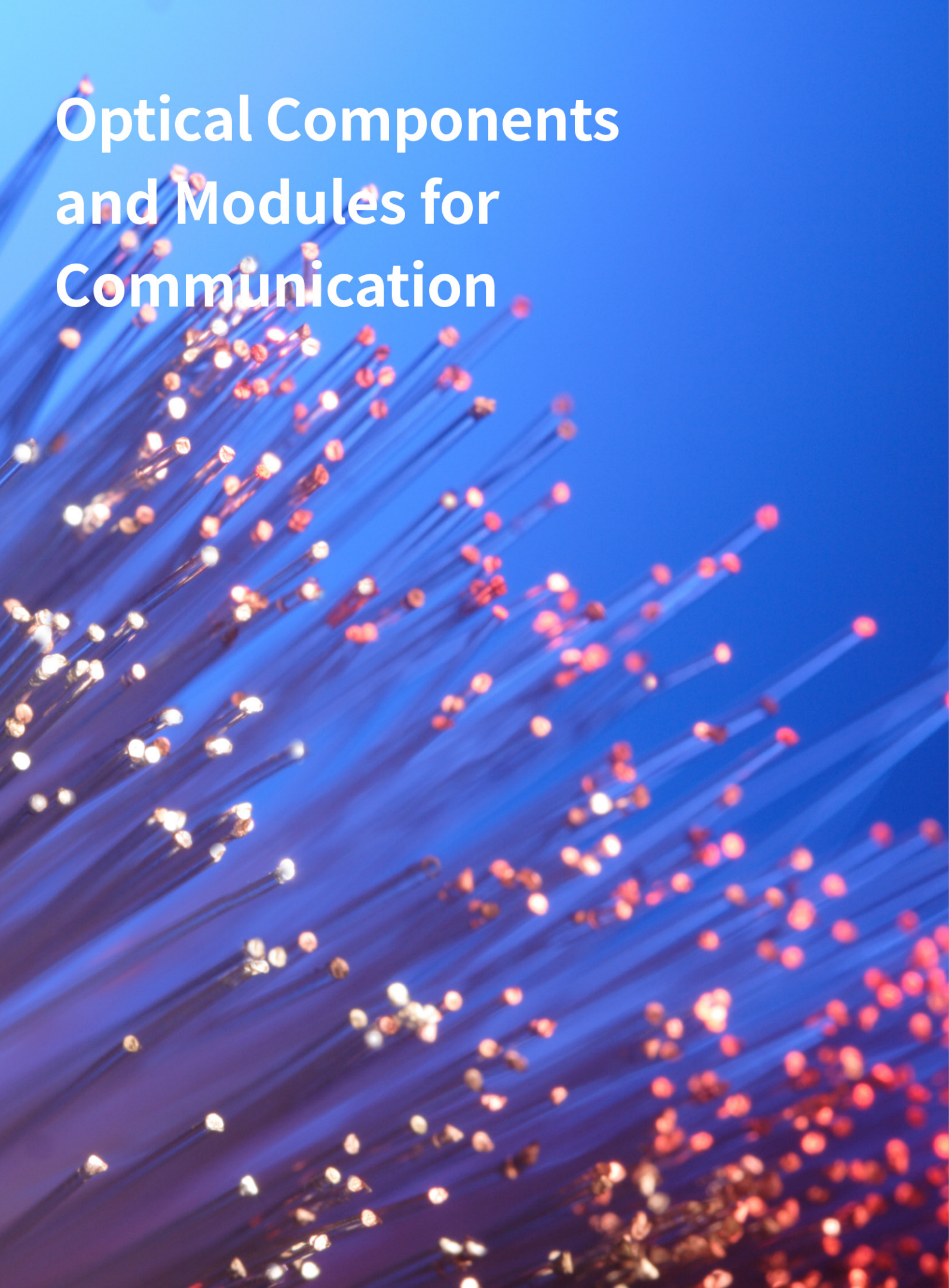

# Fibre Link Component

## OTDR FBG Reflector

OTDR FBG Reflector is based on Fiber Bragg Grating technology with wide bandwidth and low insertion loss to reflect OTDR test signal. When the optical measurement system generates a certain range of wavelength to a Passive Optical Network (PON) which can pass through the FBG, the FBG will reflect its own intrinsic reflection wavelength at 1644.5nm - 1655.5nm.

### Characteristics

- High precision of reflectance at test wavelength
- Low insertion loss at traffic wavelength
- Easy to install
- Exceptional reliability and environmental stability
- Applicable for FTTH, FTTB, FTTC
- Compatible with GPON, EPON, GEAPON, 10GEAPON, NGPON

### Applications

- Create high reflectance and wide working bandwidth at the termination of a PON without disturbing traffic
- Test the reflectance from the central office.
- Check optical continuity of a subscriber when being added, or when troubleshooting

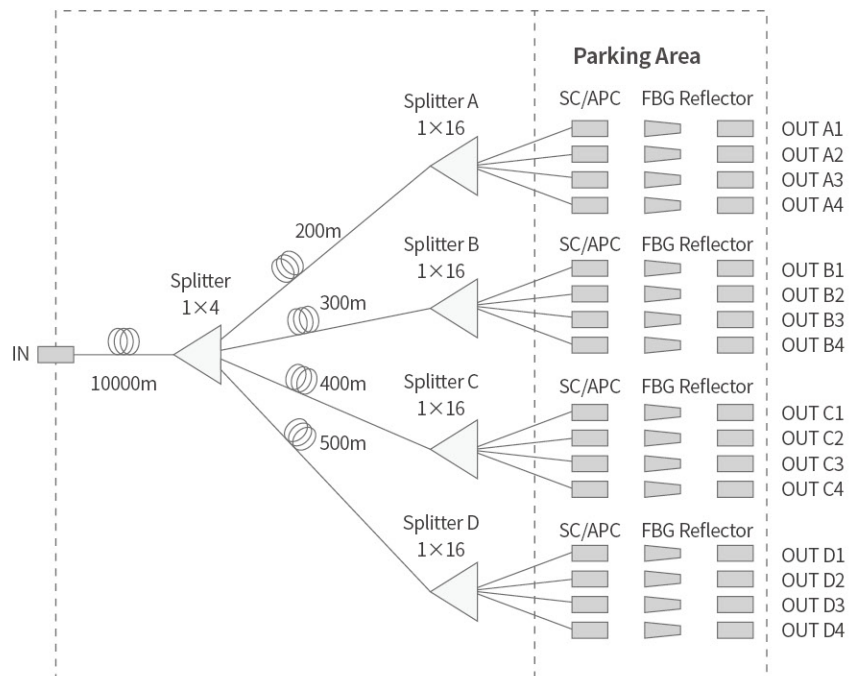



## Specifications

Product Type	REF-1650-XX-XX* <sup>①</sup>	
Parameters	Minimum	Maximum
<b>Optical Parameters</b>		
Pass band wavelength range (nm)	1260	1625
Reflect band wavelength range (nm)	1644.5	1655.5
Insertion Loss (1260nm - 1360nm) (dB)* <sup>②</sup>	-	1.0
Insertion Loss (1460nm - 1600nm) (dB)	-	1.0
Insertion Loss (1600nm - 1625nm) (dB)	-	2.0
Insertion Loss (Reflect Band) (dB)	21	-
Return Loss (1260nm - 1360nm) (dB) * <sup>③</sup>	35	-
Return Loss (1460nm - 1580nm) (dB)	35	-
Return Loss (1580nm - 1620nm) (dB)	30	-
Return Loss (1620nm - 1625nm) (dB)	20	-
Return Loss (Reflect Band) (dB)	0	1
Polarization Dependent Loss (1260nm - 1600nm) (dB)	0	0.6
Ripple (Reflect Band) (dB)	0	0.4
Temperature Dependent Loss (1260nm - 1600nm) (dB)	0	0.5
Max Optical Power Handling (dBm)	27	
Plug Times	500	-
Connector	SC/APC Male & SC/APC Female	
<b>Temperature Range</b>		
Storage Temperature (°C)	-40	85
Operating Temperature (°C)	-25	65
Relative Humidity (RH%)	5	95

\*<sup>①</sup>REF-1650-XX-XX, the first XX means fibre type, the second XX means structure type

\*<sup>②</sup> Insertion Loss (dB) =  $-10 \log(\text{Output Power} / \text{Input Power})$  [dB]

\*<sup>③</sup> Return Loss (dB) =  $-10 \log(\text{Reflected Power} / \text{Input Power})$  [dB]. To measure the return loss of reflect band, the light of 1650nm should be injected from the female side of reflector

# Optical Fibre Attenuator

The Optical Fibre Attenuator product has the function of fixed attenuator value of 2dB to 15dB, which provides fixed attenuation for the communication system, so that the communication system can achieve the appropriate output power.

## Characteristics

- Selectable diversification of attenuation values (2 dB, 3 dB, 5 dB, 7 dB, 10 dB, 15 dB)
- Cover communication band 1260nm - 1625nm
- Plug structure for easy installation
- Diverse plug types
- Precision attenuation value and high return loss
- Meet or Exceed GR-1221-CORE, GR-1209-CORE, GR-468-CORE standard specification



## Applications

- Optical distribution frame
- Optical network system
- High-speed optical fibre transmission system
- Cable TV (CATV) system
- Long-distance trunk line dense wavelength division multiplexing (DWDM) system
- Optical add / drop Multiplexer (OADM)
- High power optical device measurement

## Specifications

Product Type	ATT-XXdB-XX-XX* <sup>①</sup>		
Parameters	Minimum	Typical	Maximum
Wavelength Range (nm)	1260-1625		
Attenuation Value (dB)	2	3	5
Attenuation Range (dB)@1260nm - 1610nm	2.0 ± 0.5	3.0 ± 0.5	5.0 ± 0.5
Attenuation Range (dB)@1610nm - 1625nm	2.00 ± 0.75	3.00 ± 0.75	5.00 ± 0.75
Repeatability (dB)	2.0 ± 0.5	3.0 ± 0.5	5.0 ± 0.5
Plug in & out Times (circle)	≥ 200		
Optical Power (mW)	≥ 500		
Return Loss (dB)	≥ 45		
Connector Type	LC/UPC, SC/UPC, ST/UPC, FC/UPC, MU/UPC		
<b>Wavelength Range (nm)</b>	<b>1260 - 1625</b>		
Attenuation Value (dB)	7	10	15
Attenuation Range (dB)@1260nm - 1610nm	7.0 ± 0.7	10.0 ± 1	15.0 ± 1.5
Attenuation Range (dB)@1610nm - 1620nm	-	10.0 ± 1	15.0 ± 1.5
Attenuation Range (dB)@1610nm - 1625nm	7.00 ± 0.95	-	-
Repeatability (dB)	7.0 ± 0.5	10.0 ± 0.5	15.0 ± 0.5
Plug in & out Times (circle)	≥ 200		
Optical Power (mW)	≥ 500		
Return Loss (dB)	≥ 45		
Connector Type	LC/UPC, SC/UPC, ST/UPC, FC/UPC, MU/UPC		

\*<sup>①</sup>ATT-XXdB-XX-XX, the first XX means the attenuation value, the second XX means fibre type and the third XX means structure type

## Environmental Characteristics

Parameters	Index	
	Minimum	Maximum
Storage Temperature (°C)	- 40	85
Operating Temperature (°C)	- 5	65
Relative Humidity (RH%)	5	95

# Ultra-miniaturized Dispersion Compensation Module

In the applications of optical fibre communication and fibre laser, dispersion management is an important means to control optical parameters such as pulse and nonlinear. The ultra-miniaturized dispersion compensation fibre module(SDCM) can compensate the dispersion and dispersion slope at C-band for standard single-mode fiber(G.652) and the system residual dispersion is optimized.

## Characteristics

- 100% slope compensation of G.652 fiber in C-band (Typical)
- Optimized residual dispersion
- Broadband dispersion compensation in DWDM system
- Low insertion loss
- Low Polarization Mode Dispersion
- Small package
- Meet or exceed Telcordia GR-2854-CORE specification
- Meet or exceed Telcordia GR-21221-CORE specification
- Different package styles, connector types and pigtail lengths are available



## Applications

- Long-haul telecommunication systems with standard single-mode fiber (G.652)
- DWDM transmission systems
- SDH transmission system
- Cable AM television video systems
- Dispersion adjusting

## Specifications-1

Product Type	ADCM-10	ADCM-30	ADCM-50	ADCM-70	ADCM-90	ADCM-110
Dispersion@1545nm(ps/nm)	-170 ± 5	-500 ± 15	-835 ± 25	-1170 ± 35	-1500 ± 45	-1840 ± 55
Relative Dispersion Slope@1545nm(nm <sup>-1</sup> )	0.0036 ± 10%					
Insertion Loss(dB)*①	≤2.2	≤3.5	≤4.8	≤6.2	≤7.6	9.0
Polarization Mode Dispersion(ps)*②	≤0.3	≤0.4	≤0.5	≤0.7	≤0.8	≤0.9
Polarization Dependent Loss(dB)	≤0.1	≤0.1	≤0.1	≤0.1	≤0.1	≤0.1
Wavelength Dependent Loss(dB)	≤0.5	≤0.5	≤0.6	≤0.6	≤0.7	≤0.7
Return Loss(dB)	Connector Return Loss < -45			Module Return Loss < -27		

## Specifications-2

Product Type	ADCM-20	ADCM-40	ADCM-60	ADCM-80	ADCM-100	ADCM-120
Dispersion@1545nm (ps/nm)	-340 ± 10	-670 ± 20	-1000 ± 30	-1330 ± 40	-1670 ± 50	-2010 ± 60
Relative Dispersion Slope @1545nm(nm <sup>-1</sup> )	0.0036 ± 10%					
Insertion Loss(dB)	≤2.8	≤4.1	≤5.5	≤6.9	≤8.3	≤9.7
Polarization Mode Dispersion(ps)	≤0.3	≤0.4	≤0.6	≤0.7	≤0.8	≤0.9
Polarization Dependent Loss(dB)	≤0.1	≤0.1	≤0.1	≤0.1	≤0.1	≤0.1
Wavelength Dependent Loss(dB)	≤0.5	≤0.5	≤0.6	≤0.6	≤0.7	≤0.7
Return Loss(dB)	Connector Return Loss < -45			Module Return Loss < -27		

\*①Insertion Loss is the maximum loss over operating wavelength range(1525nm - 1565nm)

\*②PMD is average differential group delay over the wavelength range measured by Jones Matrix Method

\*Module with other compensation length can be customized

## Nonlinear Properties

Parameters	Minimum	Maximum
SBS Threshold(dBm)	6	-
Nonlinear Coeff.(n <sub>2</sub> /A <sub>eff</sub> )(W <sup>-1</sup> )	-	1.4 × 10 <sup>-9</sup>
Effective Area(A <sub>eff</sub> )(μm <sup>2</sup> )	20	-
Maximum Input Power(dBm)	-	23

## Environmental Characteristics

Parameters	Minimum	Maximum
Operating Temperature Range(°C)	-5	70
Storage Temperature Range(°C)	-40	85
Relative Humidity(%RH)	-	85
Environmental/Reliability	Meet Telcordia GR-2854 and GR-1221 Specification	

## Packing Style

Packing Style	Dimensions (mm)	Connector Type	Pigtail Length
Standard Size	185 × 175 × 36	LC/UPC or Customized	Customized
Others	Neutral Packaging or Customized		

# Ultra-miniaturized DCM for O+E+C Band

The ultra-miniaturized dispersion compensation module for O+E+C band can adjust the dispersion both at O+C-band for standard single-mode fibre (G.652), so as to optimize the residual dispersion of the system. At the same time, the module has ultra-low insertion loss at O+E+C-band.

Based on the newest TDCF design, mature and reliable processing technology, the module can improve the performance of optical transmission system. Also, ultra-miniaturized dimensions of the module can meet the requirement of system miniaturization.

## Characteristics

- Broadband dispersion compensation in DWDM system
- Ultra-low insertion loss
- Ultra-low polarization mode dispersion
- Meet or exceed Telcordia GR-2854-CORE specification
- Meet or exceed Telcordia GR-1221-CORE specification
- Ultra-miniaturized dimensions

## Applications

- Adjusting dispersion in O-band for 5G front-haul transmission system
- Long-haul telecommunication systems with standard single-mode fibre (G.652)
- DWDM transmission system
- SDH transmission system
- Cable AM television video system

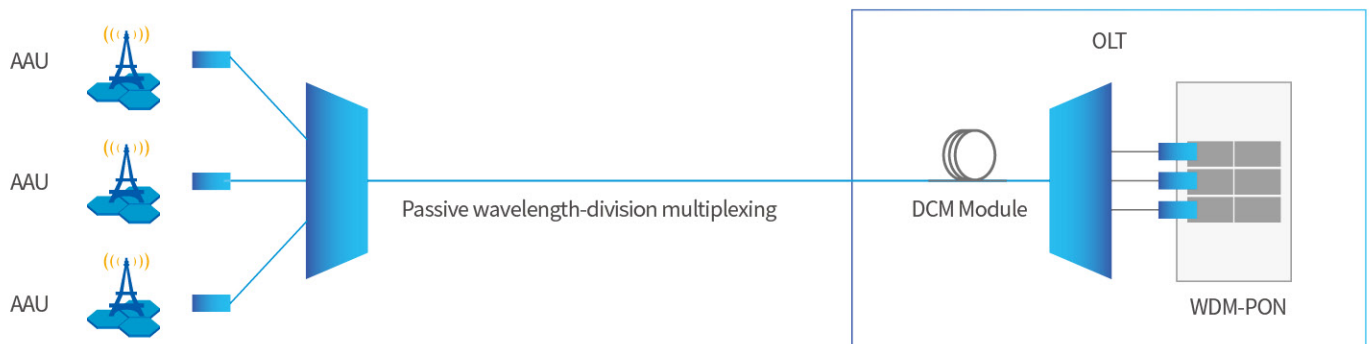

## Specifications

Product Type	AD-1KM	AD-2KM
Fibre	TDCF	
Operating Wavelength (nm)	O-band (1320 - 1375)	
	E-band (1410 - 1480)	
	C-band (1525 - 1565)	
Length (km)* <sup>①</sup>	0.95 to 1.05	1.95 to 2.05
Dispersion@1331nm (ps/nm)	-63 to -83	-130 to -162
Dispersion@1351nm (ps/nm)	-65 to -86	-133 to -168
Dispersion@1371nm (ps/nm)	-69 to -94	-142 to -184
Insertion Loss@1320 - 1375nm(dB)	≤ 2.2	≤ 3.5
Insertion Loss@1410 - 1470nm(dB)	≤ 2.4	≤ 3.7
Insertion Loss@1525 - 1565nm(dB)	≤ 1.6	≤ 2.3
Polarization Mode Dispersion (ps) * <sup>②</sup>	≤ 0.25	≤ 0.3
Polarization Dependent Loss (dB)	≤ 0.1	
Wavelength Dependent Loss@1525-1565nm (dB)	≤ 0.3	
Connector Return Loss (dB)	< -45	

\*<sup>①</sup> Other fibre length is available as requested

\*<sup>②</sup> PMD is average differential group delay over the wavelength range measured by Jones Matrix Method

## Nonlinear Properties

Parameters	Minimum	Maximum
SBS Threshold (dBm)	6	-
Nonlinear Coeff. ( $n_2/A_{eff}$ ) ( $W^{-1}$ )	-	$1.4 \times 10^{-9}$
Effective Area ( $A_{eff}$ ) ( $\mu m^2$ )	20	-

## Environmental characteristics

Item	Minimum	Maximum
Operating Temperature Range (°C)	-5	70
Storage Temperature Range (°C)	-40	85
Environmental/Reliability	Telcordia GR-2854 and GR-1221 Qualified	

## Packing Style

Packing Style	Product Type	Dimensions (mm)	Connector	Pigtail
Ultra-miniaturized Case	AD-1KM	100×100×15	LC/UPC	2.0mm loose tube, Length: 0.5 ± 0.05
	AD-2KM	125×105×20	or as Requested	Adapter
Others		Neutral Packing or as Requested		

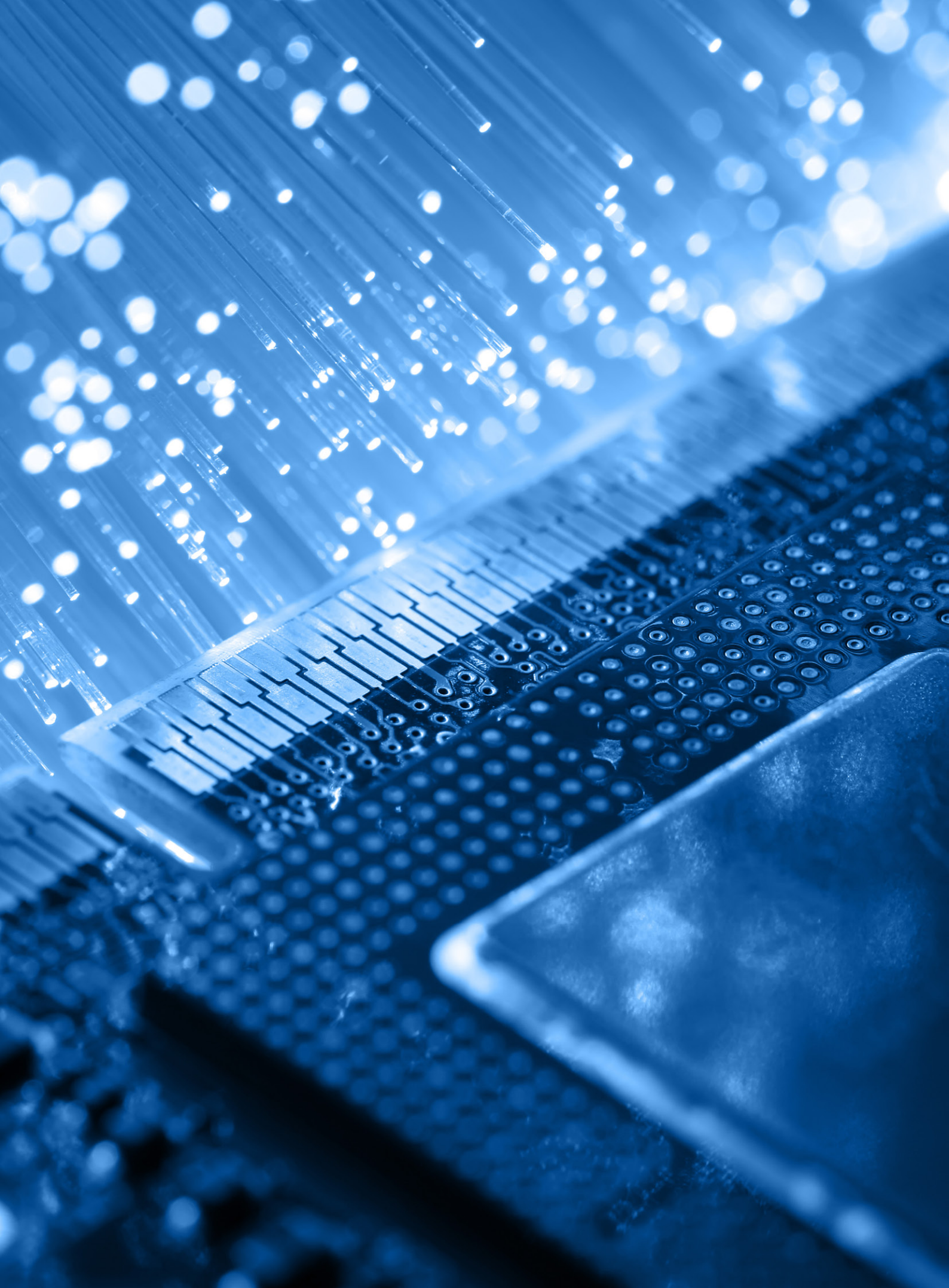



# Fibre Amplifier Component



## FBG for 980nm Pump Laser

The FBG for 980nm pump laser is written by UV light within the fibre (SMF) core. The FBG as pigtail is connected to the 980nm pump laser diode, providing external cavity feedback, which make the pump laser wavelength locked at the center wavelength of FBG. Due to the low temperature sensitivity of FBG, the stability of 980nm pump laser wavelength can be greatly improved, and the temperature control of 980nm pump laser is unnecessary. As the narrows the bandwidth of the 980nm pump laser output, the ratio of the output power within the erbium ion absorption band can be increased, thereby increasing the efficiency and the stability of the pump laser.

## Characteristics

- High-precision control of the reflective wavelength, within  $\pm 0.25\text{nm}$
- High-precision control of the reflectivity, within  $\pm 0.5\%$
- Side lobe suppression ratio up to  $-25\text{dB}$  to  $-30\text{dB}$  by apodization, better than the industry standard

Spectrum of Grating Reflection

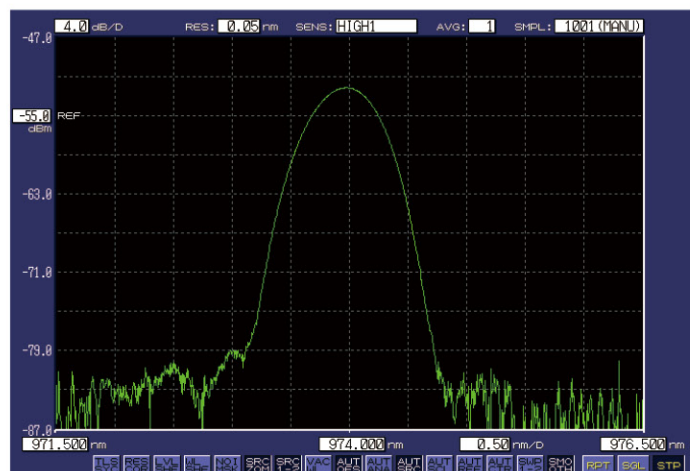

## Applications

- FBG for 980nm pump laser is used to lock output wavelength. Due to the low temperature sensitivity of FBG, the stability of output wavelength and the efficiency of 980nm pump laser can be greatly improved.

## FBG

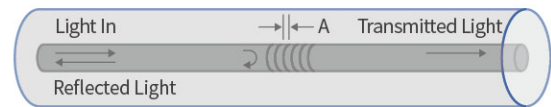

## Spectrum Response

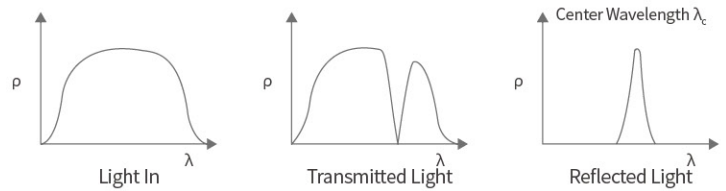

## Specifications-1

Product Type	FBG-9740-020-05-C1212		
Parameters	Minimum	Typical	Maximum
Centre Wavelength $\lambda_c$ @ 25 °C (measured "in air") (nm)*①	973.75	974.00	974.25
Peak Reflectivity @ $\lambda_c$ (%)*②	1.5	2.0	2.5
Reflectivity Bandwidth (FWHM) (nm)*③	0.4	0.5	0.6
Side Lobe Suppression Ratio Compound (SLSR) (dB)	-	-	-25
Proof Test Level (>8 sec pull test) (kpsi)	150	-	-
Bending Radius (mm)	15	-	-
Operating Temperature Range (°C)	-20	-	75
Change of Central Wavelength with Temperature (nm/°C)	0.01		
Grating Region Length (mm)	50		
Grating Type	Apodized		
Fiber Type	PMF/SMF		
Maximum Pump Power Through the Grating (W)	1		
FBG Length (m)	2 - 4 or As Requested		

## Specifications-2

Product Type	FBG-9760-030-07-C1212		
Parameters	Minimum	Typical	Maximum
Centre Wavelength $\lambda_c$ @ 25 °C (measured "in air") (nm)*①	975.85	976.00	976.15
Peak Reflectivity @ $\lambda_c$ (%)*②	2.5	3.0	3.5
Reflectivity Bandwidth (FWHM) (nm)*③	0.60	0.65	0.7
Side Lobe Suppression Ratio Compound (SLSR) (dB)	-	-	-25
Proof Test Level (>8 sec pull test) (kpsi)	150	-	-
Bending Radius (mm)	15	-	-
Operating Temperature Range (°C)	-20	-	75
Change of Central Wavelength with Temperature (nm/°C)	0.01		
Grating Region Length (mm)	50		
Grating Type	Apodized		
Fibre Type	PMF/SMF		
Maximum Pump Power Through the Grating (W)	1		
FBG Length (m)	2 - 4 or As Requested		

\*① Centre wavelength  $\lambda_c$  are available as requested from 973nm to 976nm

\*② Peak reflectivity @  $\lambda_c$  are available as requested from 0.5% to 10%

\*③ Reflectivity bandwidth (FWHM) are available as requested from 0.1nm to 1.0nm

# Optical Fibre Isolator

The optical fibre isolator is a passive optical device that only allows unidirectional light to pass through. Its working principle is based on the non-reciprocity of the Faraday rotating crystal, and the echo can be well isolated by the fibre isolator. The fibre isolator has the characteristics of high isolation, low loss, and high reliability.

## Characteristics

- Low insertion loss
- High isolation
- High stability and reliability
- High return loss

## Applications

- CATV system
- Communication system
- Optical fibre sensing system
- Test system



## Specifications

Product Type	ISO-S-1550-1-1-50-XX-N	ISO-D-1550-1-1-50-XX-N
Operating Wavelength (nm)	1550	
Operating Bandwidth (nm)	± 20	
<b>Optical Properties</b>		
Power Handling (W)	5	
Isolation (dB)	≥ 29.00	≥ 46.00
Insertion Loss (dB)	≤ 0.45	≤ 0.60
Polarization Dependent Loss (dB)	≤ 0.10	≤ 0.15
Return Loss (dB)	≥ 55.00	≥ 55.00
Polarization Mode Dispersion (ps)	≤ 0.25	≤ 0.05
<b>Environmental Properties</b>		
Operating Temperature (°C)	-5 to +70	
Storage Temperature (°C)	-40 to +85	
Relative Humidity (RH%)	5 - 95	
<b>Appearance</b>		
Dimensions (mm)	Ø5.5×35.0, Ø5.5×30.0, 8.0×12.0×70.0	
Fibre Length (m)	1.0 or Customized	

\*The parameters do not include a connector, and the fibre connector insertion loss is 0.33dB

\*XX in the product type means dimensions

# Tapering Wavelength Division Multiplexer

The wavelength division multiplexer (WDM) is a device that multiplexes different optical signals into a beam which transmits along a single optical fibre. At the receiving end, de-multiplexing is used to separate optical signals from different wavelengths. The WDM adopts the parallel fusion tapering method and has high isolation and high reliability.

## Characteristics

- Low excess loss
- Small volume
- High stability and reliability

## Applications

- Fibre amplifier system
- Wavelength division multiplexing system
- Test system



## Specifications

Product Type	WDM-1-1-3-2
Operating Wavelength (nm)	980/1550
Operating Bandwidth (nm)	± 20
<b>Optical Properties</b>	
Insertion Loss (dB)	≤ 0.15
Polarization Dependent Loss (dB)	≤ 0.10
Isolation (dB)	≥ 20.0
Return Loss (dB)	≥ 55.0
Directional (dB)	≥ 55.0
<b>Environmental Properties</b>	
Operating Temperature (°C)	-5 to +70
Storage Temperature (°C)	-40 to +85
Relative Humidity (RH%)	5 - 95
<b>Appearance</b>	
Dimensions (mm)	Ø3×35, Ø3×45, Ø3×54
Fibre Length (m)	1.0±0.1 or Customized

# CWDM Mux/Demux Module

Coarse wavelength division multiplexer (CWDM) is a low-cost WDM transmission technology for metro and access networks. In principle, CWDM is to use optical multiplexer to multiplex optical signals of different wavelengths into a single fibre for transmission. At the receiving end of the link, with the help of demultiplexer, the mixed signals in the fibre are decomposed into signals of different wavelengths and connected to the corresponding receiving equipment. Using thin film filter technology, it has the characteristics of high isolation and high reliability.

## Characteristics

- Low insertion loss, high isolation
- Excellent thermal stability
- Telcordia compliant
- RoHS compliant

## Applications

- CWDM system
- Metro and Access networks
- CATV



## Specifications

Parameters	Index				
Center Wavelength, $\lambda_c$ (nm)	1271 - 1611				
Channel Pass Band (nm)	$\pm 7.0$				
Pass Band@3dB (nm)	$\geq 15$				
Center Wavelength Offset (nm)	$\leq \pm 1.0$				
Channel Spacing (nm)	20				
Insertion Loss (dB)	4CH	6CH	8CH	12CH	16CH
	$\leq 1.4$	$\leq 1.8$	$\leq 2.2$	$\leq 3.0$	$\leq 4.0$
Pass Band Ripple (dB)	$\leq 0.5$				
Adjacent Channel Isolation(dB)	$\geq 30$				
Non-Adjacent Channel Isolation (dB)	$\geq 40$				
Polarization Dependent Loss (dB)	$\leq 0.2$				
Polarization Mode Dispersion (ps)	$\geq 0.15$				
Wavelength Temperature Stability (nm/°C)	$\geq 0.002$				
Temperature Dependent Loss (dB/°C)	$\leq 0.007$				
Return Loss (dB)	$\geq 45$				
Directivity (dB)	$\geq 50$				
Operating Temperature (°C)	-10 to +70				
Operating Humidity (%RH)	5 - 90				
Storage Temperature (°C)	-40 to +85				
Storage Humidity (%RH)	0 - 95				
Package Dimension (mm)	Customization				
Fiber Type	G657.A1				
Adaptor Type	LC/UPC				

# Optical Fibre Combiner

The multi-mode pump combiner is designed for high power EDFA. Excellent optical properties are obtained by the use of unique fusion tapering process. The input port includes two pump channels, and one signal channel, and the output port is double cladding fibre. The fibre type can be customized.

## Characteristics

- High pump efficiency
- Low insertion loss
- Customized

## Applications

- CATV system
- Communication system

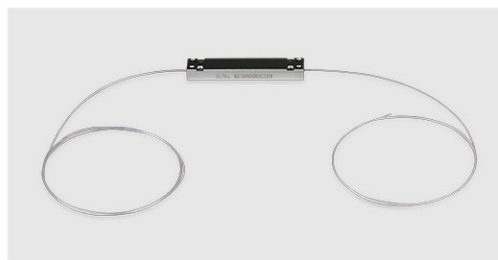

## Specifications

Product Type	MPC1-P12-S476	MPC2-P12-S476
Product Discription	(1+1) × 1 Optical Fibre Combiner	(2+1) × 1 Optical Fibre Combiner
Signal Operating wavelength (nm)	1500 - 1600, Typical 1550	
Pump Operating wavelength (nm)	800 - 1000	
<b>Fibre Type</b>		
Input Pump Fibre	SI 105/125 (0.22)	
Input Signal Fibre	G.652.D or DCF 11/125 (0.12/0.46)	
Output Fibre	DCF 11/125 (0.12/0.46)	
<b>Optical Properties</b>		
Pump Efficiency (%)	> 90 (Typical 93)	
Insertion Loss (dB)	< 0.5 (Typical 0.3)	
Isolator (dB)	≥ 25 (Typical 30)	
Max Pump Power per Port (W)	Typical 25	
<b>Environmental Properties</b>		
Operating Temperature (°C)	-5 to +70	
Relative Humidity (RH%)	5 - 95	
Storage Temperature (°C)	-40 to +85	
<b>Appearance</b>		
Dimensions (mm)	5×5×50, 8×12×70	
Fibre Length (m)	1.0	

# Active Fibre Combiner

The active fibre combiner is designed for high power EDFA. Excellent optical properties are obtained by the use of unique fusion tapering process. The input port includes two pump channels and one signal channel, and the output port is an active fibre. The fibre type can be customized.

## Characteristics

- High conversion efficiency
- Low distortion
- High pump efficiency
- Customized

## Applications

- Optical fibre amplifier power coupling

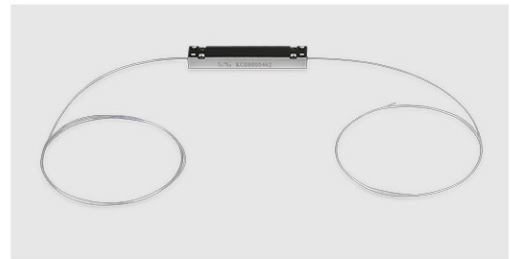

## Specifications

<b>Product Type</b>	<b>AMPC-P12-S46X</b>
Product Discription	(2+1)×1 Active Fibre Combiner
Signal Operating wavelength (nm)	1500 - 1600, Typical 1550
Pump Operating wavelength (nm)	800 - 1000
<b>Fibre Type</b>	
Input Pump Fibre	SI 105/125 (0.22)
Input Signal Fibre	DCF 11/125 (0.12/0.46)
Output Fibre	TC1500Y 11/125 (0.12/0.46)
<b>Optical Properties</b>	
Light Conversion Efficiency (%)	> 25
Insertion Loss (dB)	< 0.5 ( Typical 0.3)
Return Loss (dB)	≥ 40.0
Max Pump Power per Port (W)	Typical 25
<b>Environmental Properties</b>	
Operating Temperature (°C)	-5 to +70
Relative Humidity (RH%)	5 - 95
Storage Temperature (°C)	-40 to +85
<b>Appearance</b>	
Dimensions (mm)	8×12×70
Fibre Length (m)	1.0
Active Fibre Length (m)	3.8 or Customized





# Optical Amplifier Module

## MSA EDFA Gainblock

MSA EDFA gainblock is a kind of signal optical amplifier with compact size, which can be utilized in a variety of fields. The electrical circuit is integrated inside the module. The default control mode is AGC.

### Characteristics

- Wide operating bandwidth
- Low noise figure
- High stability and reliability
- Customized

### Applications

- Metro network and optical access network
- DWDM transmission system



### Specifications

Product Type	ERA-M-C-GBN-XX/XX-1-1/1 *①		
Parameters	Minimum	Typical	Maximum
Wavelength (nm)	1529.55	-	1563.86
Input Power (dBm)	-20	-	-4
Output Power (dBm)	0	-	20
Gain (dB)	-	25	-
Noise Figure (dB)	-	5	6
Gain Flatness (dB)	-	1.0	1.5
Return Loss (dB)	-	-	-45
Polarization Dependent Gain (dB)	-	-	0.5
Polarization Mode Dispersion (ps)	-	-	0.5
Operating Temperature (°C)	-5	-	55
Storage Temperature (°C)	-40	-	85
Power Consumption (W)	-	-	5
Communication Interface	RS232		
Electric Connector	20pins		
Optical Connector	LC/UPC or customized		
Pigtail Length (cm)	> 50		
Dimension (mm)	90(L) × 70(W) × 15(H)		

\*① ERA-M-C-GBN-XX/XX-1-1/1, the first XX means output power, and the second XX means gain

# H-MSA EDFA Module

H-MSA EDFA module is a kind of signal optical amplifier designed for DWDM transmission system with compact size, which can be integrated into EDFA card or sub rack flexibly. The control mode is ACC/APC/AGC. The high-reliability components and temperature controlling technique ensure the product excellent thermal performance under a wide temperature range.

## Characteristics

- Compact size
- Wide operating bandwidth
- Low noise figure
- High stability and reliability
- Customized

## Applications

- Metro network and optical access network
- DWDM transmission system
- 40G/100G/200G system



## Specifications

Product Type	ERA-M-C-GB/H-XX/XX-1-1/1 *①		
Parameters	Minimum	Typical	Maximum
Wavelength (nm)	1529.55	-	1563.86
Input Power (dBm)	-20	-	-4
Output Power (dBm)	0	-	20
Gain (dB)	-	25	-
Noise Figure (dB)	-	5	6
Gain Flatness (dB)	-	1	1.5
Return Loss (dB)	-	-	-45
Polarization Dependent Gain (dB)	-	-	0.5
Polarization Mode Dispersion (ps)	-	-	0.5
Operating Temperature (°C)	-5	-	55
Storage Temperature (°C)	-40	-	85
Power Supply (V)	4.75	5.00	5.25
Power Consumption (W)	-	-	10
Communication Protocol	RS232		
Electrical Connector	12 pins		
Optical Connector	LC/UPC or customized		
Pigtail Length (cm)	> 50		
Dimensions (mm)	70(L)×40(W)×8.5(H)		

\*①ERA-M-C-GB/H-XX/XX-1-1/1, the first XX means output power, and the second XX means gain

# MSA Fixed Gain EDFA Module

MSA fixed gain EDFA module is a kind of signal gain module with compact size, which has been widely utilized in DWDM transmission system. The control mode is ACC/AGC/APC. The high-reliability components and temperature controlling techniques ensure the product excellent thermal performance under a wide temperature range.

## Characteristics

- Compact MSA size
- Wide operating bandwidth
- Low noise figure
- Low power consumption
- Customized

## Applications

- Metro network and optical access network
- DWDM transmission system



## Specifications

Product Type	ERA-M-C-GB-var/XX-1-1/1 *①		
Parameters	Minimum	Typical	Maximum
Wavelength (nm)	1529.55	-	1563.86
Input Power (dBm)	-20	-	-4
Output Power (dBm)	0	-	20
Gain (dB)	-	20	-
Noise Figure (dB)	-	5	6
Gain Flatness (dB)	-	1.0	1.5
Return Loss (dB)	-	-	-45
Polarization Dependent Gain (dB)	-	-	0.3
Polarization Mode Dispersion (ps)	-	-	0.5
Operating Temperature (°C)	-5	-	55
Storage Temperature (°C)	-40	-	85
Power Supply (V)	4.75	5.00	5.25
Power Consumption (W)	-	-	10
Communication Interface	RS232		
Electrical Connector	WURTH 62503421621 or customized		
Optical Connector	LC/UPC or customized		
Pigtail Length (cm)	> 50		
Dimensions (mm)	90(L)×70(W)×15(H)		

\*① ERA-M-C-GB-var/XX-1-1/1, the XX means gain

# MSA Variable Gain EDFA Module

MSA variable gain EDFA module is specially designed for DWDM transmission system. The module can adjust gain flexible according to requirement and keep gain flatness. The control mode is ACC/APC/AGC. The high-reliability components and temperature controlling techniques ensure the product excellent thermal performance under a wide temperature range.

## Characteristics

- Gain flatness with adjustable gain
- Wide variable gain range
- Low noise figure and power consumption
- Control mode AGC/APC/ACC
- Customized

## Applications

- Metro network and optical access network
- DWDM transmission system



## Specifications

Product Type	ERA-M-C-GB-XX/var-1-1/1 *①		
Parameters	Minimum	Typical	Maximum
Wavelength (nm)	1528	-	1562
Input Power (dBm)	-35	-	5
Output Power (dBm)	-	-	18
Gain (dB)	13	-	25
Noise Figure (dB)	-	-	6
Gain Flatness (dB)	-	-	1.5
Return Loss (dB)	-	-	-45
Polarization Dependent Gain (dB)	-	-	0.5
Polarization Mode Dispersion (ps)	-	-	0.5
Operating Temperature (°C)	-5	-	55
Storage Temperature(°C)	-40	-	85
Power Supply (V)	4.75	5.00	5.25
Power Consumption (W)	-	-	10
Communication Protocol	RS232		
Electrical Connector	WURTH 62503421621 or customized		
Optical Connector	LC/UPC or customized		
Pigtail Length (cm)	> 50		
Dimensions (mm)	90(L)×70(W)×15(H)		

\*① ERA-M-C-GB-XX/var-1-1/1, the XX means output power

# C+L Band EDFA Module

C+L band EDFA module can amplify C band and L band signal simultaneously. The module can realize low noise figure and excellent gain flatness. The control mode is ACC/APC/AGC. The high-reliability components and temperature controlling techniques ensure the product excellent thermal performance under a wide temperature range.

## Characteristics

- C&L band operating bandwidth
- Low noise figure and power consumption
- High stability and reliability
- Control mode ACC/APC/AGC
- Customized

## Applications

- Metro network and optical access network
- DWDM transmission system
- Universities and Institutes



## Specifications

Product Type	ERA-M-C/L-GB-XX/XX-1-1/1 *①		
Parameters	Minimum	Typical	Maximum
Wavelength (nm)	1528 - 1567 & 1575 - 1605		
Input Power (dBm)	-35	-30	0
Output Power (dBm)	-	-10	20
Gain (dB)	-	20	-
Noise Figure (dB)	-	5.5	6
Gain Flatness (dB)	-	3.5	-
Return Loss (dB)	-	-	-45
Polarization Dependent Gain (dB)	-	-	0.5
Polarization Mode Dispersion (ps)	-	-	0.5
Operating Temperature (°C)	-5	-	50
Storage Temperature (°C)	-40	-	85
Power Supply (V)	4.75	5.00	5.25
Power Consumption (W)	-	-	20
Communication Interface	RS232		
Electric Connector	AMP 4-1470209-8 or Customized		
Optical Connector	LC/UPC or Customized		
Pigtail Length (cm)	> 50		
Dimension (mm)	130 (L) × 100 (W) × 15 (H)		

\*① ERA-M-C/L-GB-XX/XX-1-1/1, the first XX means output power, and the second XX means gain

# Mini EDFA Module

The Mini EDFA module is a single-channel or narrow-band signal amplifier module specially designed for the telecom market. The module offers XFP or QSFP compact package, which supports up to 21 dB gain and 15 dBm output power. The control mode is ACC/APC.

## Characteristics

- ACC/APC control mode
- Ultra compact structure, ultra low loss
- High stability and reliability
- Customized

## Applications

- Telecom or datacom
- CATV or SDH system

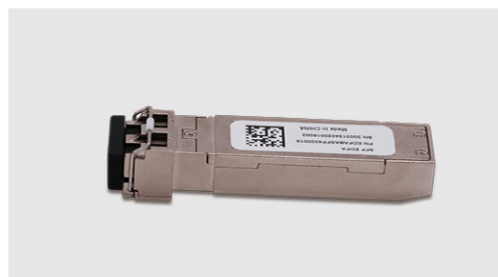

## Specifications

Product Type	ERA-S-C-SFP-XX/XX-6-1/6 *①		
Parameters	Minimum	Typical	Maximum
Wavelength (nm)	1530	-	1560
Input Power (dBm)	-6	-	6
Output Power (dBm)	-	12	15
Gain (dB)	-	20	-
Noise Figure (dB)	0	6	7
Return Loss (dB)	-	-45	-
Operating Temperature (°C)	-5	-	55
Storage Temperature (°C)	-40	-	85
Power Supply (V)	3.14	3.30	3.47
Power Consumption (W)	-	2.5	3.5
Optical Connector	LC/UPC receptacle or Customized		
Dimensions (mm)	QSFP, XFP footprint		

\*① ERA-S-C-SFP-XX/XX-6-1/6, the first XX means output gain, and the second XX means gain

# High Power EYDFA Module

The high-power eydfa module adopts two-stage amplifier structure, and the maximum output power can reach 40dBm. The module works in the mode of ACC/APC/AGC. Taking advantage of high precise temperature control technique, the module has great thermal properties in a broad range.

## Characteristics

- High power output
- ACC/APC/AGC control mode
- High stability and high reliability
- Customized

## Applications

- CATV
- FTTH
- Doppler radar system
- Universities and institute



## Specifications

Product Type	EYA-S-C-6-XX/XX-1-4/6 *①		
Parameters	Minimum	Typical	Maximum
Wavelength (nm)	1535	1550	1565
Input Power (dBm)	-3	-	10
Output Power (dBm)	30	-	40
Output Power Stability (dBm)		± 0.1	
Gain (dB)	-	40	-
Noise Figure (dB)		6	
Return Loss (dB)		≤ -45	
Gain Slope Accuracy (dBm)	0.6	0.8	1.0
Operating Temperature (°C)	-5	-	55
Storage Temperature (°C)	-40	-	85
Power Supply (V)	11.4	12.0	12.6
Power Consumption (W)	-	-	50
Communication Protocol	RS232/485		
Electrical Connector	TEM-115-02-03.0-FG-D-L1		
Optical Connector	FC/APC or Customized		
Pigtail Length (cm)	> 50		
Dimensions (mm)	200(L)×142(W)×30(H)		

\*① EYA-S-C-6-XX/XX-1-4/6, the first XX means output gain, and the second XX means gain





# Optical Amplifier

## Benchtop Optical Amplifier

Benchtop optical amplifier is specially designed for laboratory and factory testing. Highly stable components and optical path design are adopted to ensure high-performance spectral characteristics. Unique ATC and APC control mode provide stable output power. The benchtop amplifiers with excellent microprocessor control make the operation and remote control simple and intelligent.

### Characteristics

- High output power to 20 dBm
- Low noise figure and power consumption
- Control mode ACC/APC/AGC
- High reliability and stability
- Customized

### Applications

- Factory testing
- Universities and institutes



### Specifications

Product Type	ERA-M-C-TS-XX/XX-0-1/4 *①		
Parameters	Minimum	Typical	Maximum
Wavelength (nm)	1530	1550	1565
Input Power (dBm)	-20	-	10
Output Power (dBm)	-	7	20
Gain (dB)	-	25	-
NF (dB)	-	5	6
Output Stability (dB)	-	-	0.1
Operating Temperature (°C)	-5	-	55
Storage Temperature (°C)	-40	-	85
Power Supply (V)	174	220	260
Power Consumption (W)	-	-	15

\*① ERA-M-C-TS-XX/XX-0-1/4, the first XX means output gain, and the second XX means gain

# High Power EYDFA System

## 50EYA Series 1U High Power EYDFA

The 50EYA series EYDFA is an optical amplifier offering multi-port signal amplifier ranging from 1535 nm to 1565 nm. The amplifier is designed for applications of CATV and applications of 1-8 continuous band channel (ITU wavelength). It can operate at single wavelength in CATV and triple wavelength in WDM systems. This equipment of great importance in CATV backbone network can realize flat transmission in DWDM system. It supplies a flexible and low-cost solution for large-area FTTH coverage of the CATV system in large and medium cities.

### Characteristics

- Low NF pre-amplification, no cascade required, reduced CNR and MER
- Output power adjustable from 23 dBm to 37 dBm
- Perfect net management interface, compatible with SNMP protocol
- Double power supply, automatic temperature control
- LCD, on-site parameter monitoring
- High stability and reliability

### Applications

- CATV
- FTTH



## Specifications

Product Type	EYA-S-C-1U-XX/XX*①		
Parameters	Minimum	Typical	Maximum
Wavelength (nm)	1535	1550	1565
Input Power (dBm)	-5	3	10
Output Power (dBm)	26	-	37
Number of output port	SC:16/32; LC:32/64		
Output Power of Single Port (dB)	10	-	23
Output Power Stability (dBm)	±0.1		
Gain (dB)	-	40	-
Gain Flatness (dB)	-		
Noise Figure (dB)	≤ 6.0 (P <sub>in</sub> =0dBm)		
Return Loss (dB)	≤ -45		
Polarization Dependent Loss (dB)	< 0.3		
Polarization Dependent Gain (dB)	< 0.4		
Pump Power Leakage (dBm)	< -30		
Operating Temperature (°C)	-5	-	55
Storage Temperature (°C)	-40	-	85
Power Supply (V)	AC220(160 - 265) /AC110 (90 - 130) /DC48 (38 - 58)		
Power Consumption (W)	-	-	50
Communication Protocol	RS232/485		
Optical Connector	LC/APC or Customized		
Dimensions (mm)	482(L)×357(W)×44(H)		

\*① EYA-S-C-1U-XX/XX, the first XX means gain and the second XX means output power

## 50EYA Series 2U High Power EYDFA

The 50EYA series EYDFA has high output power. Operating wavelength ranging from 1535 nm to 1565 nm on this amplifier is designed for CATV and applications of 1-8 continuous band channel. This equipment is very important in CATV backbone net building. It can operate at a single wavelength in CATV and three wavelengths in WDM systems and realize flat transmission in DWDM. It supplies a flexible and low-cost solution for large-area FTTH coverage of the CATV system in big and medium cities.

### Characteristics

- Output power from 33 dBm to 40 dBm
- APC/ACC/AGC control
- Low NF pre-amplification, no cascade required, reduced CNR and MER
- Output power adjustable from 0.5 dBm to 4 dBm
- Completed net management interface, compatible with SNMP protocol
- Double power supplies, automatic temperature control
- LCD , on-site parameter monitoring
- High stability and reliability

### Applications

- CATV
- FTTH
- Doppler lidar system

### Specifications

Product Type	EYA-S-C-2U-XX/XX* <sup>①</sup>		
Parameters	Minimum	Typical	Maximum
Wavelength (nm)	1535	1550	1565
Input Power (dBm)	-5	3	10
Output Power (dBm)	33	-	40
Number of output port	SC:16/32/64; LC:32/64		
Output Power of Single Port (dB)	10	-	23
Output Power Stability (dBm)	± 0.1		
Gain (dB)	-	40	-
Gain Flatness (dB)	-		
Noise Figure (dB)	≤ 6.0 (P <sub>in</sub> =0dBm)		
Return Loss (dB)	≤ -45		
Polarization Dependent Loss (dB)	< 0.3		
Polarization Dependent Gain (dB)	< 0.4		
Pump Power Leakage (dBm)	< -30		
Operating Temperature (°C)	-5	-	55
Storage Temperature (°C)	-40	-	85
Power Supply(V)	AC220(160 - 265) /AC110 (90 - 130) /DC48 (38 - 72)		
Power Consumption (W)	-	-	100
Communication Protocol	RS232/485		
Optical Connector	LC/APC or Customized		
Dimensions (mm)	482(L)×450(W)×89(H)		

\*<sup>①</sup> EYA-S-C-2U-XX/XX, the first XX means gain and the second XX means output power

## 50EYA Series 3U High Power EYDFA

The 50EYA series EYDFA has high output power. Operating wavelength ranging from 1535 nm to 1565 nm on this amplifier is designed for CATV and applications of 1-8 continuous band channel. This equipment is very important in CATV backbone net building. It can operate at a single wavelength in CATV and three wavelengths in WDM systems and realize flat transmission in DWDM. It supplies a flexible and low-cost solution for large-area FTTH coverage of the CATV system in big and medium cities.

### Characteristics

- Max output power 43 dBm
- Low NF pre-amplification, no cascade required, reduced CNR and MER
- Parameters can be set to fulfill the different net design
- The internal optical switch can be added to expand device capability
- Output port channels from 32 to 128, WDM available
- Low noise figure: 5 dB@3 dBm input
- Completed net management interface, compatible SNMP protocol
- Double power supplies, automatic temperature control
- Output power adjustable from 0.5 dBm to 4 dBm
- True color LCD

### Applications

- CATV
- FTTH
- Doppler lidar system

### Specifications

Product Type	EYA-S-C-3U-XX/XX* <sup>①</sup>		
Parameters	Minimum	Typical	Maximum
Wavelength (nm)	1535	1550	1565
Input Power (dBm)	-5	3	10
Output Power (dBm)	-	-	43
Number of output port	SC: 16/32/64; LC: 32/64/128		
Output Power of Single Port (dB)	10	-	23
Output Power Stability (dBm)	± 0.1		
Gain (dB)	-	43	-
Gain Flatness (dB)	-		
Noise Figure (dB)	≤ 6.0 (P <sub>in</sub> =0dBm)		
Return Loss (dB)	≤ -45		
Polarization Dependent Loss (dB)	< 0.3		
Polarization Dependent Gain (dB)	< 0.4		
Pump Power Leakage (dBm)	< -30		
Operating Temperature (°C)	-5	-	55
Storage Temperature (°C)	-40	-	85
Power Supply (V)	AC160 - 250/ AC100 - 130/ DC38 - 58		
Power Consumption (W)	-	-	150
Communication Protocol	RS232/485		
Optical Connector	LC/SC or Customized		
Dimensions (mm)	482(L)×482(W)×132.5(H)		

\*<sup>①</sup> EYA-S-C-3U-XX/XX, the first XX means output power and the second XX means gain

# Optical Components for Fibre Laser



# Fibre Laser Component

## (2+1)×1 Optical Fibre Combiner

The product is designed for high power fibre laser. Unique tapering process is adopted to acquire good optical properties. The input port includes two pump channels and one signal channel, and the output port is double cladding fibre. The fibre type can be customized.

### Characteristics

- High transmission efficiency
- High pump efficiency
- Small mode distortion
- Low insertion loss
- Can be customized

### Applications

- Optical fibre amplifier power coupling

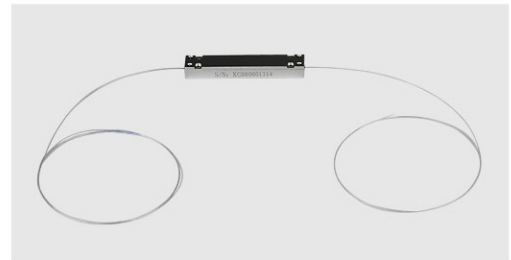

### Specifications

Parameters	Index			
<b>Product Type</b>	MPC2-P12-S322	MPC2-P12-S333	MPC2-P12-S344	MPC2-P12-S355
Signal Operating Wavelength (nm)	1000 ~ 1100, Typical 1064			
Pump Operating Wavelength (nm)	800 ~ 1000			
<b>Input Pump Port</b>				
Core/Cladding Diameter (μm)	105/125		200/220	
Numerical Aperture	0.22		0.22	
<b>Input Signal Port</b>				
Fibre Type	DCF			
Core/Cladding Diameter (μm)	10/130	20/130	20/400	30/250
<b>Output Port</b>				
Fibre Type	DCF			
Core/Cladding Diameter (μm)	10/130	20/130	20/400	30/250
<b>Optical Properties</b>				
Pump Efficiency (%)	>90 (Typical 93)			
M <sup>2</sup>	≤1.3			
Insertion Loss (dB)	<0.5 (Typical 0.3)			
Optical Isolation (dB)	≥25 (Typical 30)			
Max Pump Power (W)	Typical 10			
<b>Environmental Properties</b>				
Operating Temperature (°C)	-5 - +70			
Operating Relative Humidity (%)	5 - 95			
Storage Temperature (°C)	-40 - +85			
<b>Appearance</b>				
Dimensions (mm)	5×5×50, Φ3.5×54, 8×12×75			
Active Fibre Length (m)	1.0			

# (6+1)×1 Multi-Mode Pump Combine

This (6+1)×1 multi-mode fiber combiner is designed for high power fiber laser application. It combines six pump lasers and one signal channel into one double cladding output fiber. Fiber type can be customized.

## Characteristics

- High Signal Transmission Efficiency
- High Pump Efficiency
- High Power Handling Capability

## Applications

- Fiber Laser
- Fiber Amplifiers

## Appearance and size



## Specifications

<b>Product Type</b>	<b>MPC3-P13-S699</b>
<b>Parameters</b>	<b>Index</b>
Pump Operating Wavelength (nm)	800 - 1000
<b>Input Pump Port</b>	
Core/Cladding Diameter (μm)	YOFC 200/220
Numerical Aperture	0.22
<b>Input Signal Port</b>	
Fibre Type	YOFC GDF-DC20/400-0.065
<b>Output Port</b>	
Fibre Type	YOFC GDF-DC20/400-0.065
<b>Optical Properties</b>	
Pump Efficiency (%)	>97%
Insertion Loss (dB)	<2dB
Max Pump Power (W)	400W
<b>Environmental Properties</b>	
Operating Temperature (°C)	-5 to +70
Operating Relative Humidity (%)	5% to 85%
Storage Temperature (°C)	-40 to +85
<b>Appearance</b>	
Dimensions (mm)	10×15×150
Pigtail Length (m)	1.0

\*Fibre type can be customized



# Fibre Bragg Grating for Fibre Laser

FBG(Fibre Bragg Grating) is a periodic refractive index modulation in optical fibre core through UV exposure which can achieve the modulation of signal light in optical fibre. It is an indispensable part of a high power fibre laser.

## Characteristics

- Low temperature slope is less than 0.01°C /W under 915 nm pump power
- Central wavelength 1064nm or 1080nm
- Bandwidth operational 0.1nm~3.2nm
- Wavelength mismatch within 0.2nm
- Fibre type can be customized

## Applications

- High power fibre laser

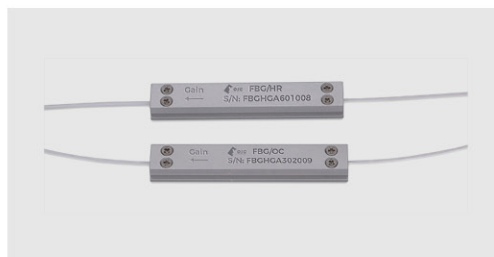

## Specifications-1

### 10/130 FBG

Product Type	FBG-1064-995-25-J0505-H	FBG-1064-100-10-J0505-O
FBG Attribute	HR	OC
Center Wavelength (nm)	1064±1	
Peak Reflectivity (%)	≥ 99.5	10 ± 2
Bandwidth (FWHM) (nm)	2.0 - 3.0	0.6 - 1.0
Wavelength Match (nm)	< 0.2	
Side Mode Suppression Ratio (dB)	> 10	
Fiber Type	YOFC GDF-10/130 or Customized	
Signal Power Handling (W)	100	
Package Type	Recoated Only	
FBG Pigtail Length	Each side 0.5m or Customized	

## Specifications-2

### 14/250 FBG

Product Type	FBG-1080-995-30-R1212-H	FBG-1080-010-10-R1212-O
FBG Attribute	HR	OC
Center Wavelength (nm)	1079 - 1081	1079 - 1081
Peak Reflectivity (%)	≥ 99.5	10 ± 2
Bandwidth (FWHM) (nm)	3 ± 0.3	1 ± 0.2
Wavelength Match (nm)	< 0.2	
Side Mode Suppression Ratio (dB)	> 10	
Fiber Type	YOFC GDF-14/250 or Customized	
Signal Power Handling (W)	1000	
Package Type	Heat Dissipation Package / Recoated Only	
FBG Pigtail Length	Each side 1.2m	

## Specifications-3

### 20/400 FBG

Product Type	FBG-1080-995-30-H1212-H	FBG-1080-010-10-H1212-O
FBG Attribute	HR	OC
Center Wavelength (nm)	1079 - 1081	1079 - 1081
Peak Reflectivity (%)	$\geq 99.5$	$10 \pm 2$
Bandwidth (FWHM) (nm)	$3 \pm 0.3$	$1 \pm 0.2$
Wavelength Match (nm)	<0.2	
Side Mode Suppression Ratio (dB)	>10	
Fiber Type	YOFC GDF-20/400 or Customized	
Signal Power Handling (W)	2000	
Package Type	YOFC Heat Dissipation Package / Recoated Only	
FBG Pigtail Length	Each side 1.2m	

## Specifications-4

### 25/400 FBG

Product Type	FBG-1080-995-30-S1212-H	FBG-1080-010-10-S1212-O
FBG Attribute	HR	OC
Center Wavelength (nm)	1079 - 1081	1079 - 1081
Peak Reflectivity (%)	$\geq 99.5$	$10 \pm 2$
Bandwidth (FWHM) (nm)	$3 \pm 0.3$	$1 \pm 0.2$
Wavelength Match (nm)	<0.2	
Side Mode Suppression Ratio (dB)	>10	
Fiber Type	YOFC GDF-25/400 or Customized	
Signal Power Handling (W)	3000	
Package Type	YOFC Heat Dissipation Package	
FBG Pigtail Length	Each side 1.2m	

## Dimensions of Heat Dissipation Package

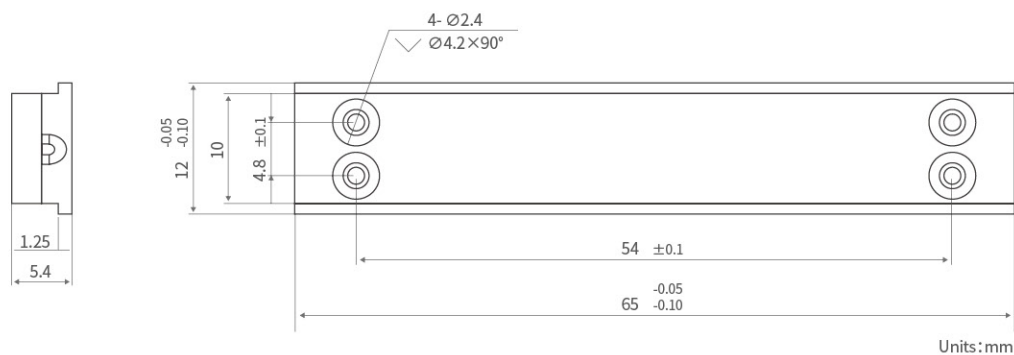



**YANGTZE(Wuhan)OPTICAL SYSTEM CORP., LTD**

**ADD:** No.9 Optics Valley Avenue, Wuhan, Hubei, China(P.C.: 430073)

**Tel:** +86 136-3864-0865

**Email:** ganquan@yofc.com

© 202106 YOSC All Rights Reserved